

Low-Cost MADOCA PPP Receiver Systems

MAD MAD MADROID

Dinesh Manandhar
CSIS, The University of Tokyo
dinesh@csis.u-tokyo.ac.jp
4th June 2020

Low-Cost MADOCA PPP Receiver Systems

MAD MAD MADROID

Type A: MAD-PI	Type B: MAD-WIN	Type C: MADROID
<ul style="list-style-type: none"> • Platform / OS : RaspberryPi • Receiver : Dual Frequency Receiver • Data Format : UBX, SBF or RTCM 3 • Correction Data : UBX, RTCM3 or JAXA online • Under debugging and test 	<ul style="list-style-type: none"> • Platform / OS : MS Windows • Receiver : Dual Frequency Receiver • Data Format : UBX, SBF or RTCM 3 • Correction Data : UBX, RTCM3 or JAXA online • Under debugging and test 	<ul style="list-style-type: none"> • Platform / OS : Android Device • Receiver : Dual Frequency Receiver • Data Format : UBX or RTCM 3 • Correction Data : JAXA online • Under debugging and test

MADOCA Low-Cost Receiver Systems

Type – A : MAD-PI

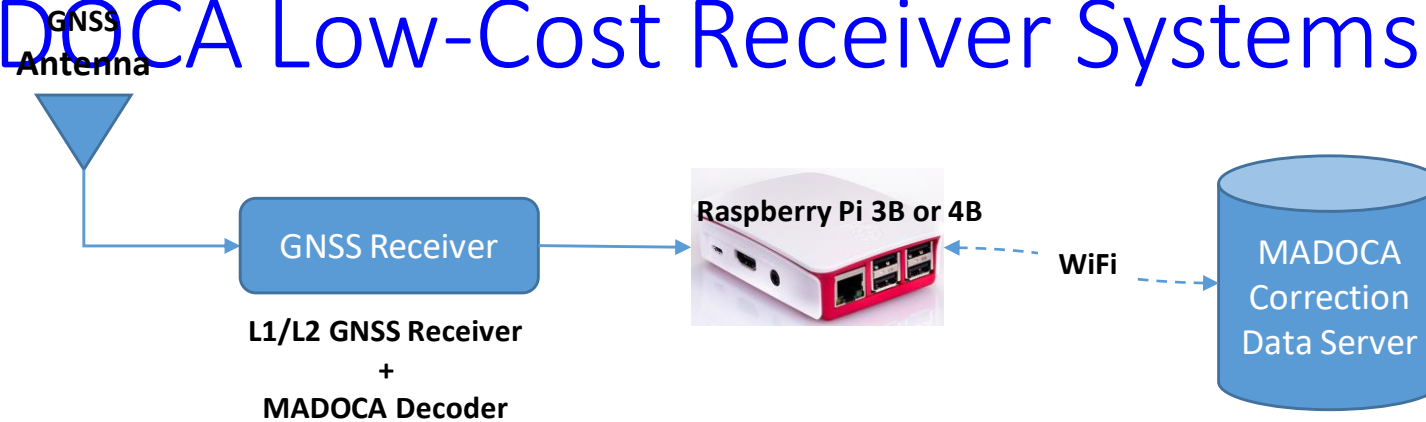

Use MADOCA correction data from server if GNSS receiver does not have MADOCA decoder

Type – B : MAD-WIN

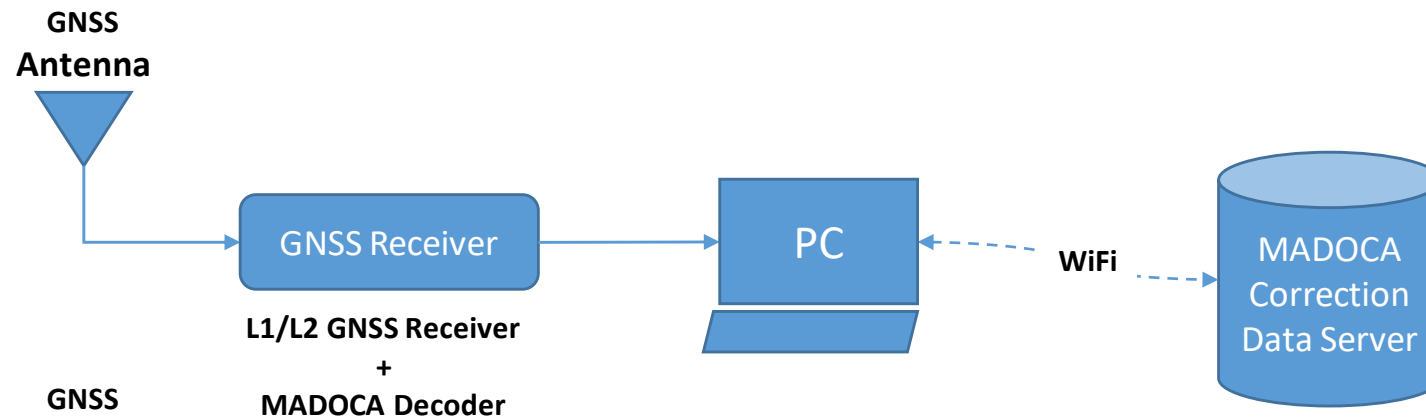

Use MADOCA correction data from server if GNSS receiver does not have MADOCA decoder

Type – C : MADROID

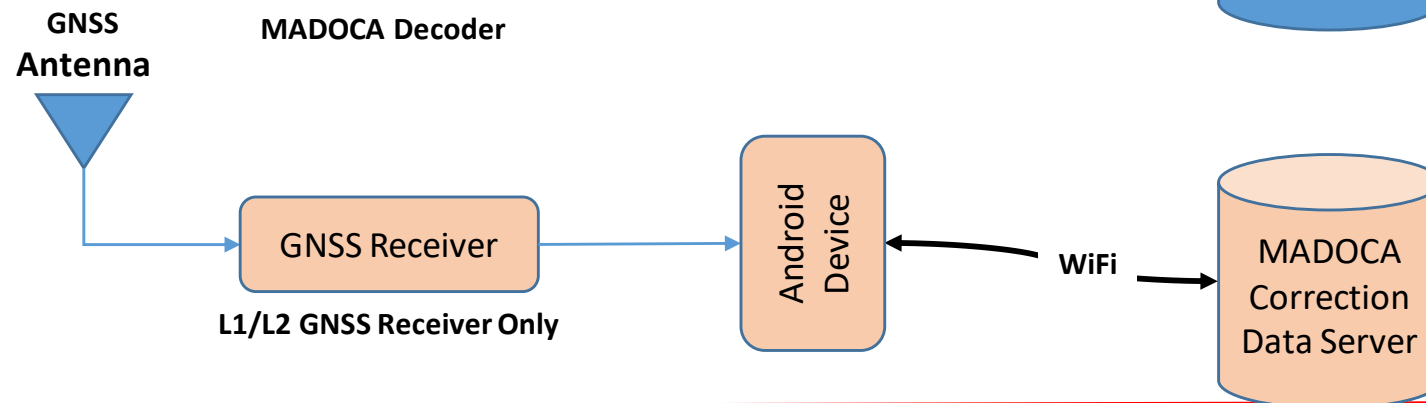

Use MADOCA correction data from server

GNSS MADOCA Receiver and Antenna

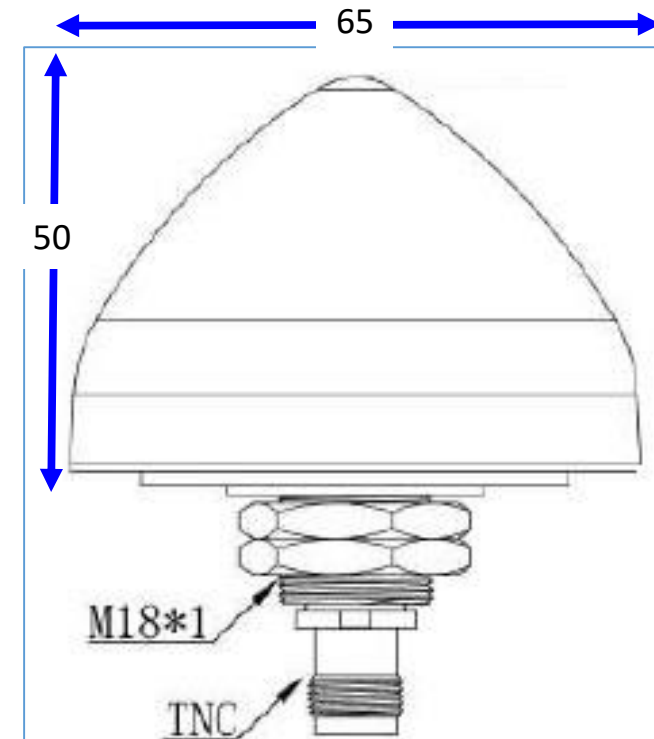

Receiver System Architecture

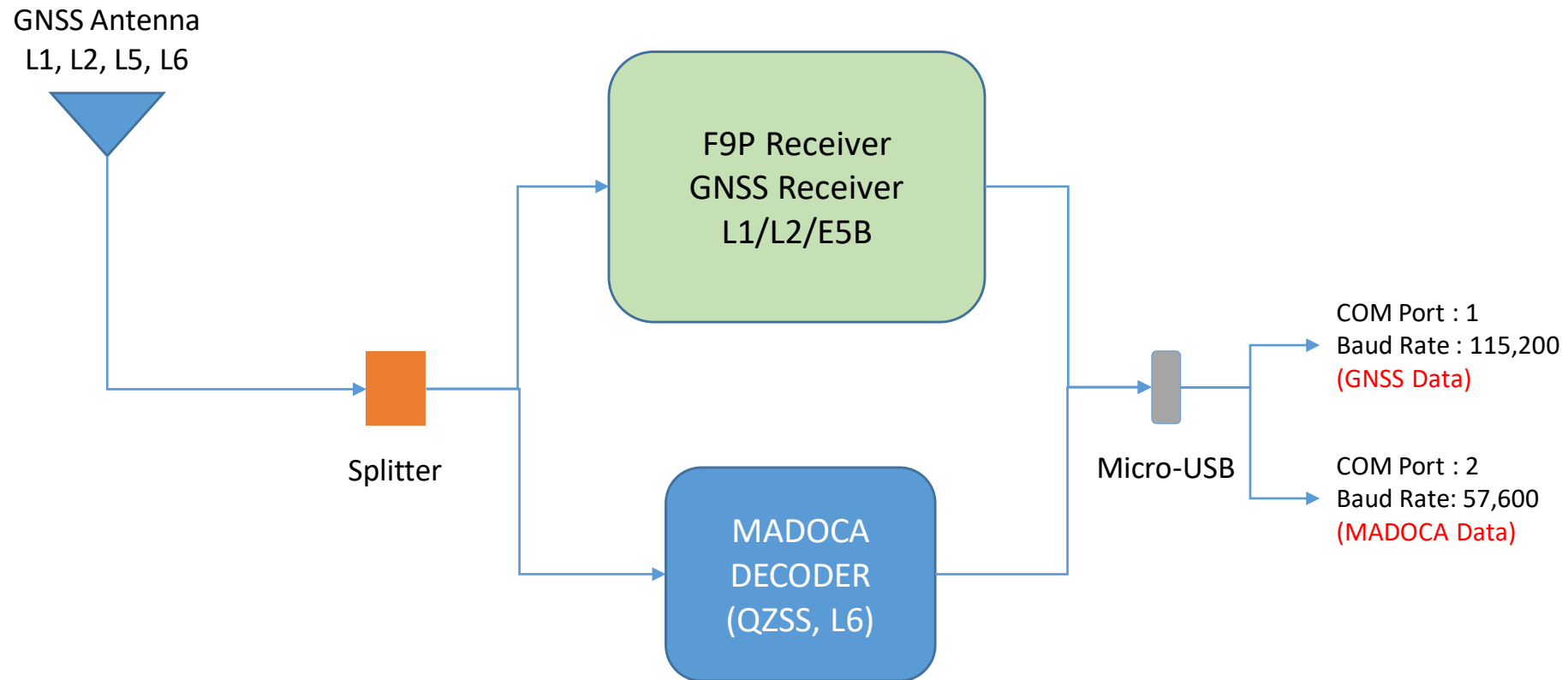

GNSS Raw Data, F9P Receiver Output

UBX - RXM (Receiver Manager) - RAWX (Multi-GNSS Raw Measurement Data) 471

Local Time 2108:364155.001000000 [s]

Leap seconds 18 (VALID) [s] Clock reset

SV	Sign...	G...	Pseudo Range [m]	Carrier Phase [c...]	Dopple...	Lock T...	SNR	PR Std...	CP Std...	DO St...	P...	C...	H...
G03	L1C/A	-	21647431.89	113758026.20	1766.7	64500	47	0.08	0.004	0.064	Y	Y	Y
G07	L1C/A	-	24915724.27	130933010.83	-3266.5	64500	40	0.16	0.008	0.256	Y	Y	Y
G08	L1C/A	-	23275226.57	122312137.25	-2627.7	64500	48	0.08	0.004	0.064	Y	Y	Y
G22	L1C/A	-	21510039.63	113036022.46	-299.5	64500	51	0.08	0.004	0.032	Y	Y	Y
G30	L1C/A	-	24278609.23	127584953.13	-2644.0	64500	39	0.32	0.012	0.512	Y	Y	Y
Q01	L1C/A	-	37653530.29	197870641.68	-73.0	64500	45	0.08	0.004	0.064	Y	Y	Y
B13	B1D1	-	39143654.13	203831280.88	4.6	64500	44	0.08	0.004	0.128	Y	Y	Y
B23	B1D1	-	25258313.11	131526650.97	-3329.3	64500	45	0.08	0.004	0.128	Y	Y	Y
B33	B1D1	-	24290016.20	126484489.71	1997.9	64500	44	0.08	0.004	0.128	Y	Y	Y
B07	B1D1	-	36355222.61	189311179.89	-935.5	64500	40	0.16	0.008	0.256	Y	Y	Y
B14	B1D1	-	23562278.42	122694967.85	744.2	64500	46	0.08	0.004	0.128	Y	Y	Y
B08	B1D1	-	37559872.35	195584111.77	-297.2	64500	36	0.32	0.012	0.256	Y	Y	Y
R14	L10F	-7	20799394.57	110872489.66	-1915.9	64500	41	1.28	0.008	0.128	Y	Y	Y
R07	L10F	5	24916190.47	133378314.32	-3400.1	4880	31	2.56	0.023	0.512	Y	Y	Y
R08	L10F	6	22339471.45	119626854.33	-756.2	0	22	10.24	-	8.192	Y	N	N
R13	L10F	-2	22903427.46	122303024.15	-4716.8	64500	38	1.28	0.008	0.256	Y	Y	Y
R15	L10F	0	22497781.39	120221322.41	1857.6	900	30	1.28	0.027	1.024	Y	Y	N
R23	L10F	3	21577264.34	115423832.34	-2281.8	64500	39	1.28	0.008	0.256	Y	Y	Y
Q02	L1C/A	-	37387370.90	196471961.13	-586.0	64500	44	0.08	0.004	0.128	Y	Y	Y
E25	E1C	-	25156832.92	132200035.35	-2745.3	64500	47	0.16	0.004	0.064	Y	Y	Y
Q07	L1C/A	-	37723026.81	198235850.73	-456.2	64500	42	0.08	0.008	0.128	Y	Y	Y
E04	E1C	-	27608611.14	145084222.79	787.6	64500	40	0.32	0.008	0.128	Y	Y	Y
G32	L1C/A	-	26205245.91	137709496.61	23.5	0	19	10.24	-	8.192	Y	N	N
E24	E1C	-	27082376.41	142318876.30	-3603.2	64500	30	1.28	0.023	0.512	Y	Y	Y
B34	B1D1	-	27305668.25	142187779.36	-2696.7	64500	40	0.16	0.008	0.256	Y	Y	Y
R17	L10F	4	22576755.59	120812779.20	1583.3	0	24	5.12	-	2.048	Y	N	N
R24	L10F	2	20561599.24	109952111.10	-571.8	0	24	5.12	-	2.048	Y	N	N

UBX - RXM (Receiver Manager) - RAWX (Multi-GNSS Raw Measurement Data) 119 s

Local Time 2108:364155.001000000 [s]

Leap seconds 18 (VALID) [s] Clock reset

SV	Sign...	G...	Pseudo Range [m]	Carrier Phase [c...]	Dopple...	Lock T...	SNR	PR Std...	CP Std...	DO St...	P...	C...	H...
R24	L10F	2	20561599.24	109952111.10	-571.8	0	24	5.12	-	2.048	Y	N	N
G11	L1C/A	-	21725325.52	114167355.90	-2393.9	0	19	10.24	-	8.192	Y	N	N
E09	E1C	-	25953366.03	136385811.26	2082.8	31320	31	0.64	0.020	0.512	Y	Y	Y
B07	B2D1	-	36355217.75	146387393.88	-723.3	64500	46	0.08	0.004	0.128	Y	Y	Y
B13	B2D1	-	39143656.89	157615286.40	3.7	64500	41	0.08	0.008	0.256	Y	Y	Y
B08	B2D1	-	37559865.78	151238004.56	-230.1	64500	36	0.32	0.012	0.512	Y	Y	Y
B14	B2D1	-	23562274.77	94875513.57	575.2	64500	47	0.08	0.004	0.128	Y	Y	Y
E09	E5BQ	-	25953376.32	104503489.05	1595.4	7200	30	0.32	0.023	0.512	Y	Y	Y
E25	E5BQ	-	25156838.06	101296166.80	-2103.6	64500	46	0.08	0.004	0.064	Y	Y	Y
E04	E5BQ	-	27608614.87	111168447.66	603.2	64500	38	0.08	0.008	0.256	Y	Y	Y
E24	E5BQ	-	27082389.38	109049567.15	-2761.8	64500	29	0.32	0.020	0.256	Y	Y	Y
G03	L2CL	-	21647433.43	88642630.21	1376.6	64500	42	0.16	0.008	0.128	Y	Y	Y
G07	L2CL	-	24915724.70	102025717.75	-2545.6	64500	31	0.64	0.027	1.024	Y	Y	Y
G08	L2CL	-	23275228.17	95308161.74	-2047.7	64500	43	0.08	0.004	0.128	Y	Y	Y
G30	L2CL	-	24278610.59	99416856.48	-2060.6	64500	39	0.32	0.008	0.256	Y	Y	Y
Q01	L2CL	-	37653530.82	154184923.80	-56.7	64500	39	0.32	0.008	0.256	Y	Y	Y
R13	L20F	-2	22903428.93	95124586.38	-3668.6	64500	33	1.28	0.020	0.512	Y	Y	Y
R14	L20F	-7	20799400.97	86234179.82	-1489.7	64500	30	1.28	0.027	1.024	Y	Y	Y
R07	L20F	5	24916072.27	103738199.24	-2645.2	0	24	5.12	-	2.048	Y	N	N
R08	L20F	6	22339431.21	93042941.92	-588.8	0	24	10.24	-	8.192	Y	N	N
Q07	L2CL	-	37723023.32	154469487.54	-355.4	64500	40	0.32	0.008	0.256	Y	Y	Y
Q02	L2CL	-	37387371.70	153095048.86	-456.7	64500	45	0.16	0.004	0.128	Y	Y	Y

GNSS Navigation Data Bits, F9P Receiver Output

UBX - RXM (Receiver Manager) - SFRBX (Subframe Data NG) 13 s

denotes data received on subChn Strip Parity Bits

SV	MSG	DATA (* denotes invalid words)
BDS 7 B1D1 0	1	38901595 02980070 05E0B162 2289108A 06070A96 3D450F44 1DD669E1 18007A25 14EABF2E 2F05E156
BDS 7 B2D1 0	??	38901595 02980070 05E0B162 2289108A 06070A96 3D450F44 1DD669E1 18007A25 14EABF2E 2F05E156
BDS 8 B1D1 0	1	38901595 02980070 05E0B162 2286EFB5 36070AD6 3D450F44 1DD669E1 18006C2A 3C41FFEB 33B34166
BDS 8 B2D1 0	??	38901595 02980070 05E0B162 2286EFB5 36070AD6 3D450F44 1DD669E1 18006C2A 3C41FFEB 33B34166
BDS 10 B2D1 0	??	38901595 02980070 05E0B162 2283E0B1 1A070A56 3D450F44 1DD669E1 18006E2C 0C7CE03A 05A1C1D5
BDS 11 B1D1 0	1	38901595 02981075 05E0B162 228280B3 0B070A26 3D450F44 1DD669E1 18006522 16DCFFFD 32BEA2F6
BDS 11 B2D1 0	??	38901595 02981075 05E0B162 228280B3 0B070A26 3D450F44 1DD669E1 18006522 16DCFFFD 32BEA2F6
BDS 13 B1D1 0	1	38901595 02980070 05E0B162 22BA002D 18070A26 3D450F44 1DD669E1 18001E24 3B5500B6 0B14E149
BDS 13 B2D1 0	??	38901595 02980070 05E0B162 22BA002D 18070A26 3D450F44 1DD669E1 18001E24 3B5500B6 0B14E149
BDS 14 B1D1 0	1	38901595 0298607D 05E0B162 2283C0B8 09070C5C 3D04D0F5 0D8679E4 181E207E 00CDA0D2 1A4E47DA
BDS 14 B2D1 0	??	38901595 0298607D 05E0B162 2283C0B8 09070C5C 3D04D0F5 0D8679E4 181E207E 00CDA0D2 1A4E47DA
BDS 23 B1D1 0	1	38901595 02981075 05E0B162 228FD382 3D070AF6 3D450F44 1DD669E1 1800472E 27AF000B 0443615C
BDS 33 B1D1 0	1	38901595 02981075 05E0B162 22A57976 17070AE6 3D450F44 1DD669E1 18004A2A 0D37001B 04A26173
BDS 34 B1D1 0	2	38902597 00D09C8C 33ECCB8E 05C8F99E 232801B3 0A4DDB09 031AB08C 3C98F45A 10AA517C 141A296F
GAL 2 E1B 0	E0	00955555 55555555 55555555 50F14000 A415C000 0000002A AAAA58DA E9FF4000
GAL 4 E1B 0	E0	00955555 55555555 55555555 50F14000 A42E4000 0000002A AAAA6D4B BEFF4000
GAL 4 E5BI 0	??	0217B097 823989B5 6CE3F207 B3830000 BC014000 0000002A AAAABF45 DC7F4000
GAL 9 E1B 0	E0	00955555 55555555 55555555 50F14000 A42E4000 0000002A AAAA6D4B BEFF4000
GAL 9 E5BI 0	??	051CFFC4 05E07FBF E00878B2 118A8000 AAAA8000 0000002A AAAAAEDE 737F4000
GAL 11 E1B 0	E3	03177FF1 C8C61EBA FC868642 A1798000 955AC000 0000002A AAAA795D FC3F4000
GAL 11 E5BI 0	??	00955555 55555555 55555555 50F14000 A4160000 00000015 5555608A B07F4000
GAL 24 E1B 0	E7	07E25E4C 00E05304 3BCFE129 7F070000 ABD54000 0000002A AAAA4C78 9FFF4000
GAL 24 E5BI 0	??	00955555 55555555 55555555 50F14000 A3F10000 0000002A AAAAB461 6CBF4000
GAL 25 E1B 0	E0	00955555 55555555 55555555 50F14000 A42E4000 0000002A AAAA6D4B BEFF4000
GAL 25 E5BI 0	??	021785E9 82624A02 2B8CABA1 EDA20000 82C74000 0000002A AAAA9472 F2BF4000
GAL 30 E1B 0	E0	00955555 55555555 55555555 50F14000 A3D3C000 0000002A AAAA7FF5 6EFF4000
GLO 1 L1OF 1	2 3/2504	10A10006 74AC20D0 78711800
GLO 2 L1OF -4	2 3/2504	10A10022 91CC07E5 65214000

GNSS Navigation Data Bits, F9P Receiver Output

UBX - RXM (Receiver Manager) - SFRBx (Subframe Data NG) 71 s

denotes data received on subChn Strip Parity Bits

SV	MSG	DATA (* denotes invalid words)
GLO 2 L10F -4	2 3/2504	10A10022 91CC07E5 65214000
GLO 2 L20F -4	2 3/2504	10A10022 91CC07E5 65214000
GLO 7 L10F 5	6 5/2501	35A842C3 4440F5BC 0EED4800
GLO 7 L20F 5	10 1/2501	551C096A 6F50889C 3E27D800
GLO 8 L10F 6	2 3/2504	10A1040B 2CE0277F 380D2000
GLO 8 L20F 6	1 3/2504	08212942 7FF8AF7F 223CA800
GLO 13 L10F -2	2 3/2504	10A10486 0400930A 8830F800
GLO 13 L20F -2	2 3/2504	10A10486 0400930A 8830F800
GLO 14 L10F -7	2 3/2504	10A10093 CE099683 2074A800
GLO 14 L20F -7	2 3/2504	10A10093 CE099683 2074A800
GLO 15 L10F 0	2 3/2504	10A10152 2E914D06 669C7000
GLO 15 L20F 0	14 3/2503	757C390F B86090C4 16F93000
GLO 17 L10F 4	2 3/2504	10A104E4 A2A19390 B3843000
GLO 17 L20F 4	5 2/2504	289B0000 00001C00 0266D000
GLO 23 L10F 3	2 3/2504	10A10524 BE8864C2 D88C7000
GLO 23 L20F 3	11 1/2500	5EA47CC2 5F74C01A 1A57B000
GLO 24 L10F 2	1 3/2504	08212CD7 68C06759 09094800
GPS 3 L1C/A 0	3	22C03C33 1DAE88B3 000228A7 1FB3BA61 800149FD 960AD940 07C6477A 8118C462 BFE9CB02 8846D75B
GPS 3 L2CM 0	45 ??	8B0CB76B A260D13F 7E0C89D6 09F9800F B1B62001 0001E003 2CC01FAD C01C9800 2D9A0EDC 3EA8B0DE
GPS 7 L1C/A 0	3	22C03C33 1DAE88B3 3FFDBE0D 9183B133 001B49A8 3675A4E1 84A227A7 20971BBB 3FE9BFEB 15BC0E58
GPS 7 L2CM 0	45 ??	8B1CB76B A2617C23 1ABB8986 75FF9FFE 6F15C014 A002A007 E2E01388 00307500 72D8AEC9 EBC8B1DE
GPS 8 L1C/A 0	3	22C03C33 1DAE88B3 0000132F 21E748D7 000849DB 1FCE65D1 8AA27F7C 11A57C92 BFE93AA9 827C5AE3
GPS 8 L2CM 0	45 ??	8B20B76B A2612643 E28C49DF CED97FCE 0F18A006 4002BFF2 ADC02B04 400941FF 45D451F5 7A18B21E
GPS 11 L1C/A 0	4/57/1	22C03C33 1DA72CE7 1E46BC59 8976A283 1AD5A5FA ADE00DCB 2529F154 0B0C412F 00DC3CB9 8150FBC7
GPS 14 L1C/A 0	2	22C03C33 1DA96AE7 06BEDCD9 8D4B5D04 14D45B4F 3F000179 B8393A99 8407686C 034AD445 96699F8B
GPS 17 L1C/A 0	3	22C03C33 1DACABFB 000F93CC 1FD0BA3B 3FF70A26 852DBA93 0A1B2F58 04D8B2F2 BFEAB01F 0C7CBD97
GPS 22 L1C/A 0	3	22C03C33 1DAE88B3 001127AF 3D911B6C 3FFA095F 3B03EA06 87083477 1D4CD7C4 3FE922F8 0806C397
GPS 27 L1C/A 0	1	22C03C33 1DAD094F 03C40037 095100B9 9C3CAE5E B8B6246E 90488135 85966957 003FEA16 B5CB19BC

GNSS Navigation Data Bits, F9P Receiver Output

UBX - RXM (Receiver Manager) - SFRBX (Subframe Data NG) 106 s

denotes data received on subChn Strip Parity Bits

SV	MSG	DATA (* denotes invalid words)
GLD 17 L10F 4	2 3/2504	10A104E4 A2A19390 B3843000
GLD 17 L20F 4	5 2/2504	289B0000 00001C00 0266D000
GLD 23 L10F 3	2 3/2504	10A10524 BE8864C2 D88C7000
GLD 23 L20F 3	11 1/2500	5EA47CC2 5F74C01A 1A57B000
GLD 24 L10F 2	1 3/2504	08212CD7 68C06759 09094800
GPS 3 L1C/A 0	3	22C03C33 1DAE8BB3 000228A7 1FB3BA61 800149FD 960AD940 07C6477A 8118C462 BFE9CB02 8846D75B
GPS 3 L2CM 0	45 ??	8B0CB76B A260D13F 7E0C89D6 09F9800F B1B62001 0001E003 2CC01FAD C01C9800 2D9A0EDC 3EA8B0DE
GPS 7 L1C/A 0	3	22C03C33 1DAE8BB3 3FFDBE0D 9183B133 001B49A8 3675A4E1 84A227A7 20971BBB 3FE9BFEB 15BC0E58
GPS 7 L2CM 0	45 ??	8B1CB76B A2617C23 1ABB89B6 75FF9FFE 6F15C014 A002A007 E2E01388 00307500 72D8AEC9 EBC8B1DE
GPS 8 L1C/A 0	3	22C03C33 1DAE8BB3 0000132F 21E748D7 000849DB 1FCE65D1 8AA27F7C 11A57C92 BFE93AA9 827C5AE3
GPS 8 L2CM 0	45 ??	8B20B76B A2612643 E28C49DF CED97FCE 0F18A006 4002BFF2 ADC02B04 400941FF 45D451F5 7A18B21E
GPS 11 L1C/A 0	4/57/1	22C03C33 1DA72CE7 1E468C59 8976A283 1AD5A5FA ADE00DCB 2529F154 0B0C412F 00DC3CB9 8150FBC7
GPS 14 L1C/A 0	2	22C03C33 1DA96AE7 06BEDCD9 8D4B5D04 14D45B4F 3F000179 B8393A99 8407686C 034AD445 96699F8B
GPS 17 L1C/A 0	3	22C03C33 1DACABFB 000F93CC 1FD0BA3B 3FF70A26 852DBA93 0A1B2F58 04D8B2F2 BFEAB01F 0C7CBD97
GPS 22 L1C/A 0	3	22C03C33 1DAE8BB3 001127AF 3D911B6C 3FFA095F 3B03EA06 87083477 1D4CD7C4 3FE922F8 0806C397
GPS 27 L1C/A 0	1	22C03C33 1DAD094F 03C40037 095100B9 9C3CAE5E B8B6246E 90488135 85966957 003FEA16 B5CB19BC
GPS 30 L1C/A 0	3	22C03C33 1DAE8BB3 00043E5C 0C51D14C 0003C9A5 902E535C 044EA2FC 210F9F12 BFE9C6CA 8F3C845B
GPS 30 L2CM 0	45 ??	8B78B76B A2617C98 B7334990 2EC4A015 8F1EE005 A0072007 DCC0126C 802FD500 6D9E0B57 AA78B79E
GPS 32 L1C/A 0	1	22C03C33 1DAD094F 03C40037 095100B9 9C3CAE5E B8B6246E 9048806D 89966986 80000FF7 099E73F0
GPS 32 L2CM 0	45 ??	8B80B76A 2261666E 242549BD E8917FFA BE593FEF 60071FFB 68A01D6A E01E99FF C094FB52 9148B81E
QZSS 1 L1C/A 0	3	22C0AA24 1DAE835C 013F2D52 8F43A1DC 3EFE477D A38B4E4D 8884B03B 1F97CD75 BFFAF44D AD458C97
QZSS 1 L2CM 0	??	8B04B76B A2645A9E 8F1B8763 81E965F7 30741FD1 BFEA200F EC0022A0 5FED0500 7088081D E568B05F
QZSS 2 L1C/A 0	3	22C0AA81 9DAE8383 0034848A 91413ED8 00A98799 A75FE251 8214EFF4 1F3CE46E BFFA75FC 2D413300
QZSS 2 L2CM 0	??	8B08B76B A2640922 7E75C7A7 5CC5A780 50C9A039 1FE0E051 814015D2 A009FA03 1B680231 1B98B09F
QZSS 3 L1C/A 0	1	22C0AA81 9DADA1E3 03C840C6 A0000003 00000000 00000000 00000053 2D56698E 803FFF2A BFE0F804
QZSS 3 L2CM 0	??	8B0CA76B 11078264 62640472 E320A5D A10C1FFC 6C68CFEB FCF931B1 63C702C6 5CEB04CD 1958B0CB
QZSS 7 L1C/A 0	3	22C0AA81 9DAE8383 01F52A2B 28751B08 00F8801D 82F38171 90DAF61A 8A9167D5 800335EF 2D400037
QZSS 7 L2CM 0	??	8B1CB76B A2645450 EA35C002 F3814CC5 900000F8 81F4E053 6340436B 5FB4EE02 D8F00DFE EF08B1DF

Satellite System & Signal Settings

F9P Receiver

UBX - CFG (Config) - GNSS (GNSS Config)

ID	GNSS	Configure	Enable	Channels		Signals
				min	max	
0	GPS	<input checked="" type="checkbox"/>	<input checked="" type="checkbox"/>	8	16	<input checked="" type="checkbox"/> L1C/A
1	SBAS	<input type="checkbox"/>	<input type="checkbox"/>	0	0	<input type="checkbox"/> L1C/A
2	Galileo	<input checked="" type="checkbox"/>	<input checked="" type="checkbox"/>	10	18	<input checked="" type="checkbox"/> E1
3	BeiDou	<input checked="" type="checkbox"/>	<input checked="" type="checkbox"/>	4	5	<input checked="" type="checkbox"/> B1
4	IMES	<input type="checkbox"/>	<input type="checkbox"/>	0	0	<input type="checkbox"/> L1C/A
5	QZSS	<input checked="" type="checkbox"/>	<input checked="" type="checkbox"/>	0	4	<input checked="" type="checkbox"/> L1C/A <input type="checkbox"/> L1S
6	GLONASS	<input checked="" type="checkbox"/>	<input checked="" type="checkbox"/>	8	12	<input checked="" type="checkbox"/> L10F
7	IRNSS					

Number of channels available:

Number of channels to use: Auto set

MADOCA Decoder

UBX - CFG (Config) - GNSS (GNSS Config)

ID	GNSS	Configure	Enable	Channels		Signals
				min	max	
0	GPS	<input type="checkbox"/>	<input type="checkbox"/>	0	0	<input type="checkbox"/> L1C/A
1	SBAS	<input type="checkbox"/>	<input type="checkbox"/>	0	0	<input type="checkbox"/> L1C/A
2	Galileo	<input type="checkbox"/>	<input type="checkbox"/>	0	0	<input type="checkbox"/> E1
3	BeiDou	<input type="checkbox"/>	<input type="checkbox"/>	0	0	<input type="checkbox"/> B1
4	IMES	<input type="checkbox"/>	<input type="checkbox"/>	0	0	<input type="checkbox"/> L1C/A
5	QZSS	<input checked="" type="checkbox"/>	<input checked="" type="checkbox"/>	0	54	<input type="checkbox"/> L1C/A <input type="checkbox"/> L1S
6	GLONASS	<input type="checkbox"/>	<input type="checkbox"/>	0	0	<input type="checkbox"/> L10F
7	IRNSS					

Number of channels available:

Number of channels to use: Auto set

Satellite System and Signal Settings

F9P Receiver

Basic			Advanced				
ID	System	Enable	Signals Control				
0	GPS	<input checked="" type="checkbox"/>	<input checked="" type="checkbox"/> L1C/A	<input type="checkbox"/> L1C	<input checked="" type="checkbox"/> L2C	<input type="checkbox"/> L5	
1	SBAS	<input type="checkbox"/>	<input type="checkbox"/> L1C/A				
2	Galileo	<input checked="" type="checkbox"/>	<input checked="" type="checkbox"/> E1	<input type="checkbox"/> E5a	<input checked="" type="checkbox"/> E5b	<input type="checkbox"/> E6	
3	BeiDou	<input checked="" type="checkbox"/>	<input checked="" type="checkbox"/> B1	<input type="checkbox"/> B1C	<input checked="" type="checkbox"/> B2	<input type="checkbox"/> B2a	
4	IMES	<input type="checkbox"/>	<input type="checkbox"/> L1				
5	QZSS	<input checked="" type="checkbox"/>	<input checked="" type="checkbox"/> L1C/A	<input type="checkbox"/> L1C	<input type="checkbox"/> L1S	<input checked="" type="checkbox"/> L2C	<input type="checkbox"/> L5
6	GLONASS	<input checked="" type="checkbox"/>	<input checked="" type="checkbox"/> L1	<input type="checkbox"/> L10C	<input checked="" type="checkbox"/> L2	<input type="checkbox"/> L3	
7	IRNSS	<input type="checkbox"/>	<input type="checkbox"/> L5				

MADOCA Decoder

Basic			Advanced				
ID	System	Enable	Signals Control				
0	GPS	<input checked="" type="checkbox"/>	<input type="checkbox"/> L1C/A	<input type="checkbox"/> L1C	<input type="checkbox"/> L2C	<input type="checkbox"/> L5	
1	SBAS	<input type="checkbox"/>	<input type="checkbox"/> L1C/A				
2	Galileo	<input type="checkbox"/>	<input type="checkbox"/> E1	<input type="checkbox"/> E5a	<input type="checkbox"/> E5b	<input type="checkbox"/> E6	
3	BeiDou	<input type="checkbox"/>	<input type="checkbox"/> B1	<input type="checkbox"/> B1C	<input type="checkbox"/> B2	<input type="checkbox"/> B2a	
4	IMES	<input type="checkbox"/>	<input type="checkbox"/> L1				
5	QZSS	<input checked="" type="checkbox"/>	<input type="checkbox"/> L1C/A	<input type="checkbox"/> L1C	<input type="checkbox"/> L1S	<input checked="" type="checkbox"/> L2C	<input type="checkbox"/> L5
6	GLONASS	<input type="checkbox"/>	<input type="checkbox"/> L1	<input type="checkbox"/> L10C	<input type="checkbox"/> L2	<input type="checkbox"/> L3	
7	IRNSS	<input type="checkbox"/>	<input type="checkbox"/> L5				

Show Hex

MADOCA Correction Data Output

Received Directly from QZSS L6E Channel

[14:27:58.559]	0000	B5 62 02 73 08 01 01 07 5D 23 0C D0 04 00 0A 00	µb.s....]#.Đ....
	0010	00 65 00 00 1A CF FC 1D D1 21 AC 97 12 0F 10 85	.e...İü.Ñ!~.....
	0020	64 B8 16 C0 00 00 20 C4 40 09 C6 FF D8 97 FF DC	d..Ä.. Ä@.Äyø.yü
	0030	FF FF AE 00 0F 7F FF 79 12 7F F8 98 00 6D D8 04	ÿÿ®...ÿÿ..ø..mø.
	0040	CC FF F9 60 A8 DF 80 03 13 86 BF F5 BF 00 43 71	ÿÿü"ß....¿ø¿.Cq
	0050	01 D5 FF F9 6F FF 96 FF FB 5E B1 80 35 CF FF E5	.øÿüøÿ.yü^±.5ÿyá
	0060	5F FF 41 FF F4 01 FF 93 FF 5D 90 2A FF D4 E8 00	_ÿÄyø.y.ÿ].*ÿøè.
	0070	7C D1 EC 97 FF ED 40 00 4C 00 1E 22 62 00 F3 4F]Ñi.yi@.L.."b.óó
	0080	FF 0C 80 1C 27 FF DC C0 01 E7 FF 9E 4D 9C 01 B3	y...yüÄ.cÿ.M..³
	0090	A0 10 84 FF D8 BF FF 30 80 04 DF FF 36 01 47 FE	..ÿø¿ÿø..ÿÿ6.gp
	00A0	9E 20 07 83 FF C6 9F FF 8C FF D4 60 00 1C F6 95	...ÿÄ.y.yø`..ø.
	00B0	64 B4 76 80 00 00 41 84 9A 49 C4 9E 8D 04 22 4A	d'v...A..IÄ..."J
	00C0	64 A8 48 00 00 00 00 00 00 00 00 00 00 00 00	d"H.....
	00D0	00 00 00 00 00 00 00 00 00 00 00 00 00 00 00
	00E0	00 00 00 00 00 00 00 00 00 00 00 00 00 23 82 2C#.,
	00F0	0A 87 D3 13 8D F9 F2 1B CC AD 1F 77 8C 1D 34 59	..ó..ùð.î~.w..4ÿ
	0100	2D 09 B1 19 05 CD 99 BA C3 BE DC 55 5B 76 83 08	-..±..í.°Ä%ÜU[v...
[14:27:59.510]	0000	B5 62 02 73 08 01 01 02 9A 25 F3 D3 04 00 0F 02	µb.s....%óó....
	0010	00 14 00 00 1A CF FC 1D CC 21 AC 97 22 0F 10 99İü.î!~.."...
	0020	64 B9 05 60 00 00 D8 5F F2 C3 87 FF B0 08 BF FD	d'.._ø_ðÄ.y°.¿ÿ
	0030	83 0F FE F8 81 1F F9 07 93 FF 7D 29 40 07 25 96	..þø..ù..ÿ})@.%.
	0040	01 42 E9 9F F1 CF 1A 00 DA D9 C0 12 21 9F FF A6	.Bé.ñİ..ÜÜÄ.!..ÿ
	0050	CA 00 04 61 A3 FF 22 A2 7F F4 6D A8 00 B8 62 A0	É..afÿ"ç.ôm".b
	0060	01 2F AD FF 3F 7B 1F F0 88 B2 00 9E 63 5F FD DC	./-ÿ?{.ð.²..c_ÿü
	0070	36 00 00 C3 80 2A 75 BB FF F1 4B C0 08 F3 3F FF	6..Ä.*u»ÿñKA.ó?ÿ
	0080	D5 6C 1F FB B1 90 B0 EE 04 2A 00 00 04 83 F9 08	ó .ü±.°í.*....ù.
	0090	98 BF 30 59 1F C7 4C E4 F8 BC 98 BF 67 4D 1F ED	.¿Oÿ.çLäø%.¿gm.í
	00A0	FF 54 7B 91 D6 CF C8 D0 5B F7 EA F3 BF 3F 3A 7F	ÿT{.ÖİËÐ[÷éø¿?::
	00B0	E0 24 11 FB 85 9A 5F B2 AB CF F0 26 3A 7E 71 71	à\$.ü.._²«İð&:~qq
	00C0	5F AE F7 AF FB 18 E6 3E C2 BE 13 8D 64 B9 05 40	_ø÷~ü.æ>Ä%.d'.@
	00D0	00 00 23 FF C6 88 00 00 00 00 00 00 00 00 00	..#ÿÄ.....
	00E0	00 00 00 00 00 00 00 00 00 00 00 00 00 00 A1 53jS
	00F0	91 E6 BA C8 F2 6C D7 B9 49 5E 21 02 65 D8 86 FE	.æ°Èð x¹I^!.eø.p
	0100	54 FD 64 0D BE 60 64 07 B2 DE 9F A2 69 22 10 3E	Týd.%`d.²p.çi".>.

Type A: MAD-PI

MADOCA PPP based on RaspberryPi / Dual Frequency Receiver + MADOCA Decoder

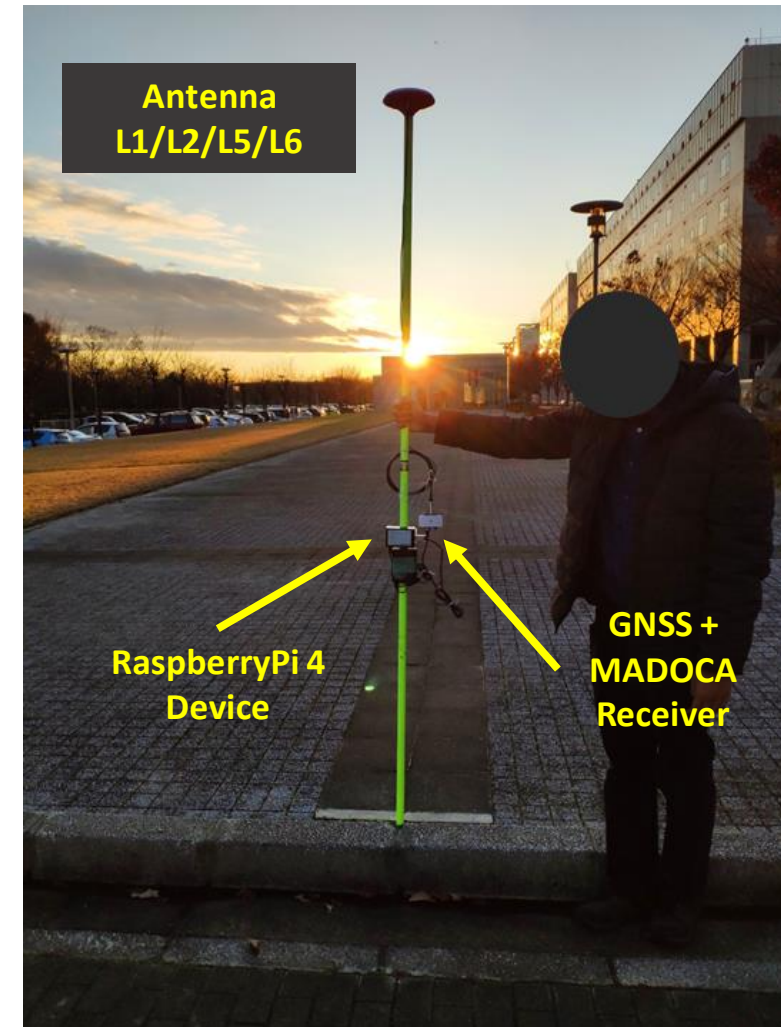

Type B: MAD-WIN

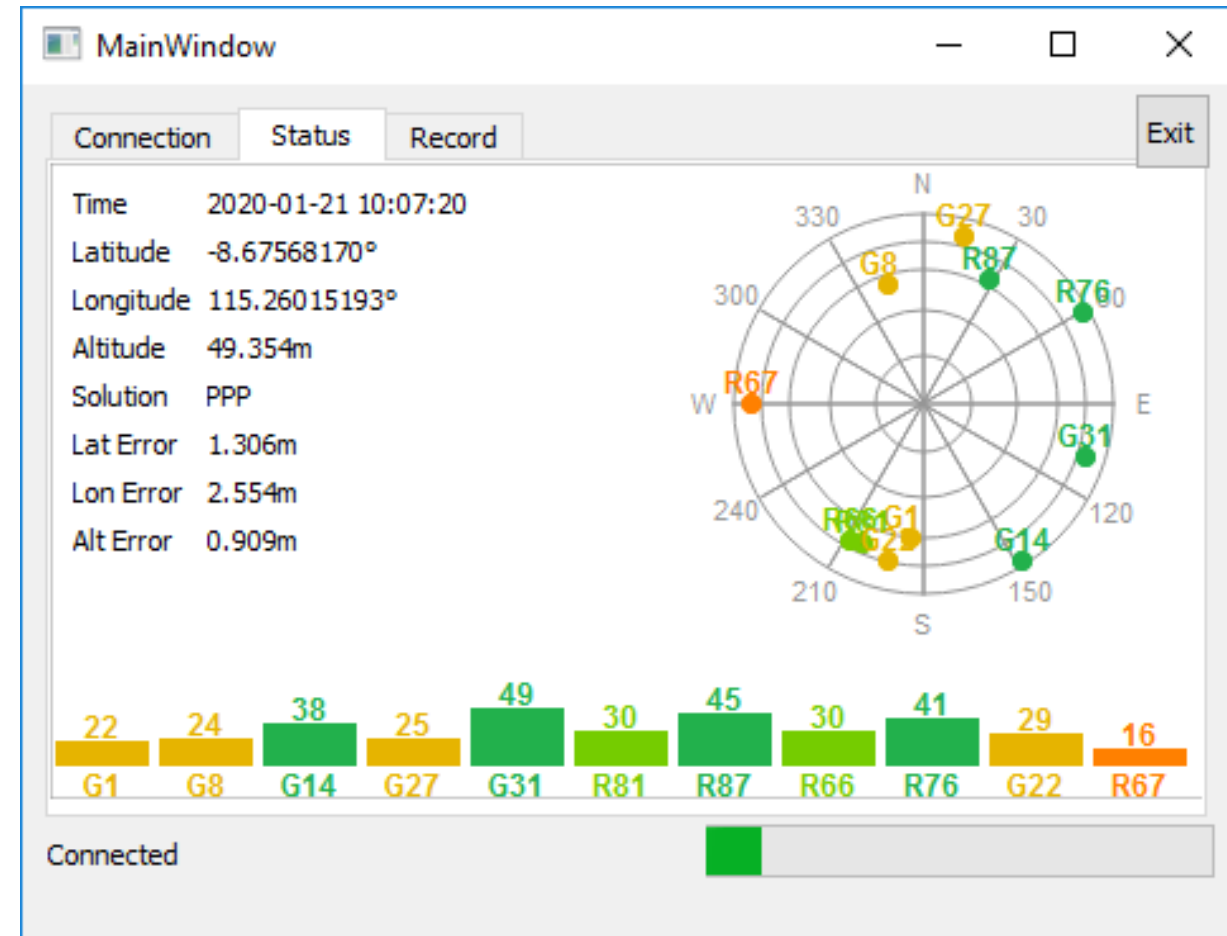
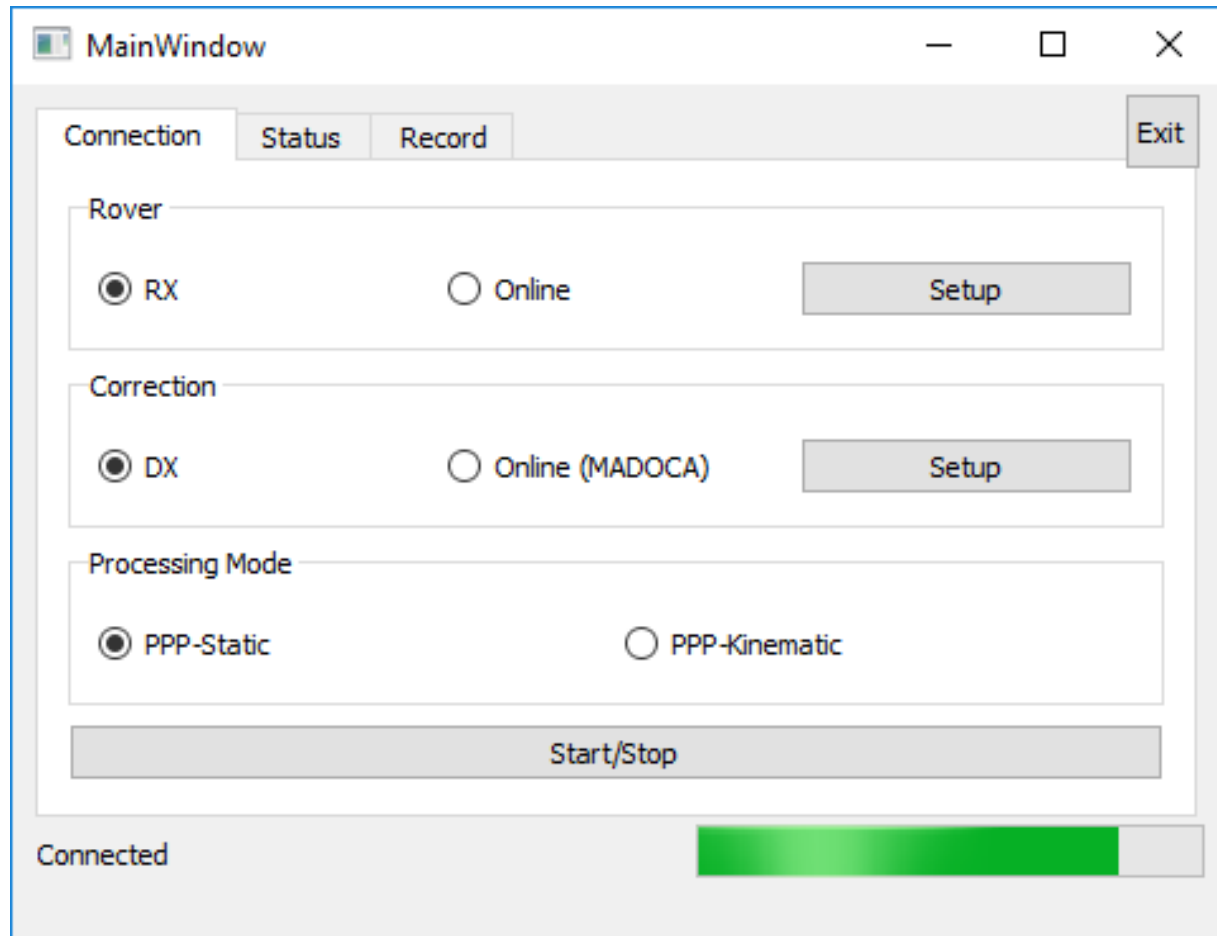

The position accuracy improves to cm (10 – 30 cm) level after initialization time of about 15min.

Type B: MAD-WIN

Receiver: Online receiver access in Kashiwa / Correction Data: MADOCA Receiver in Bali

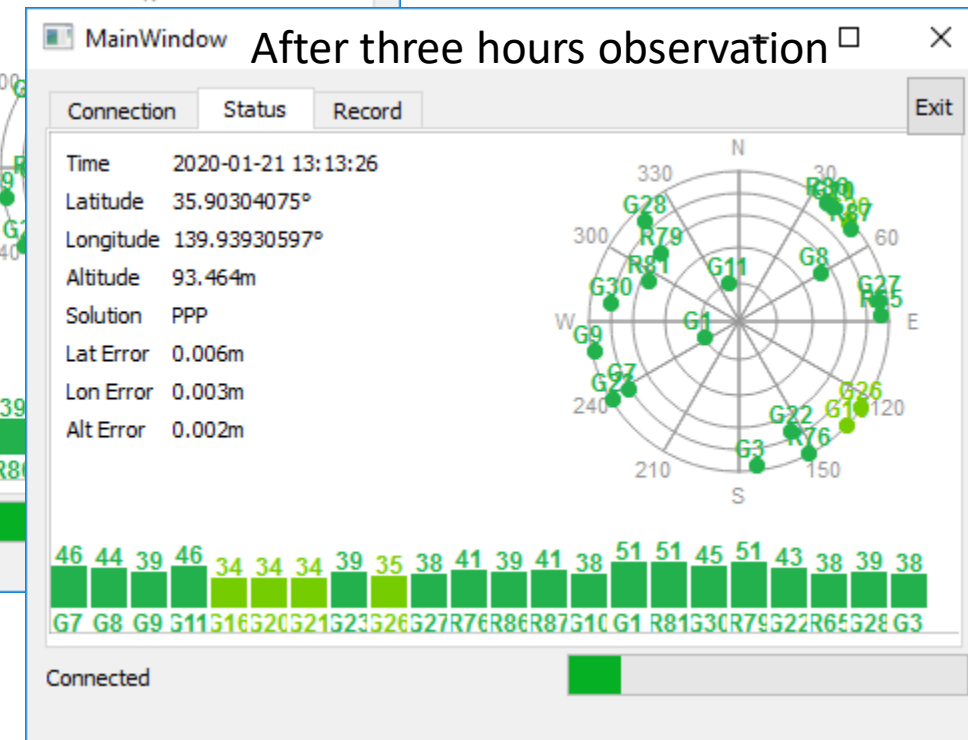
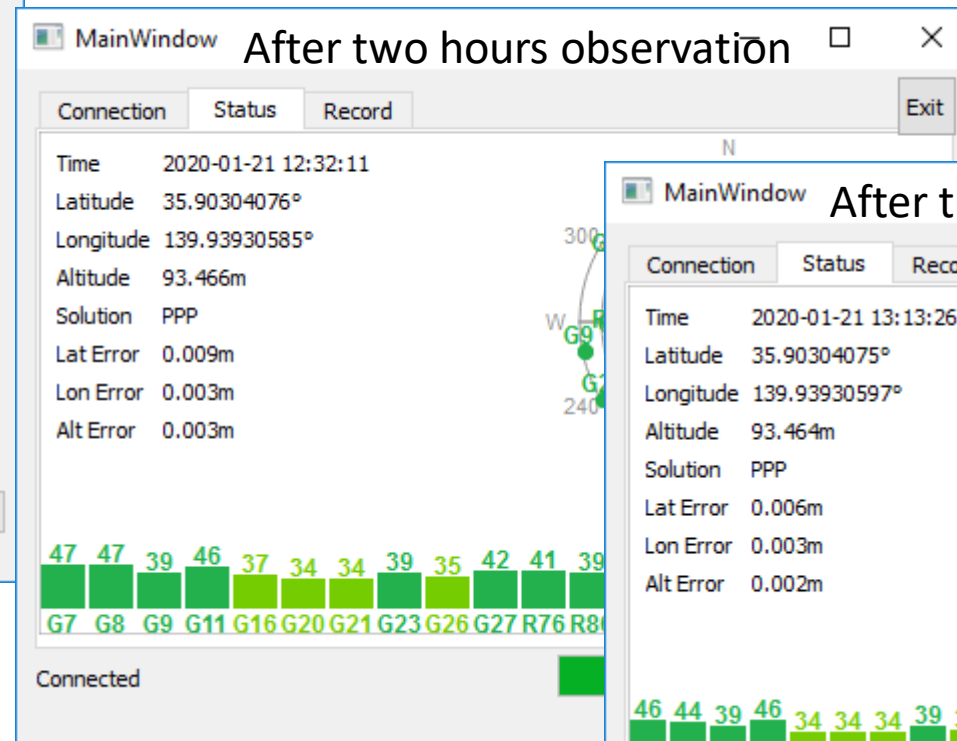
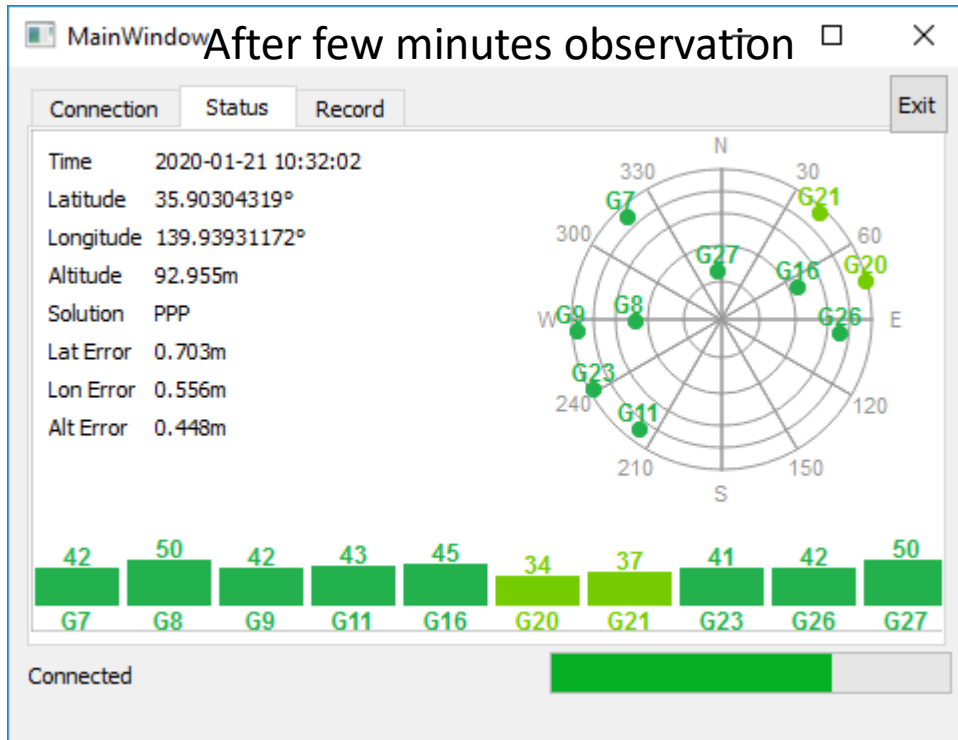

Type C: MADROID / MADOCA PPP based on Android Dual Frequency Receiver + Online MADOCA Data

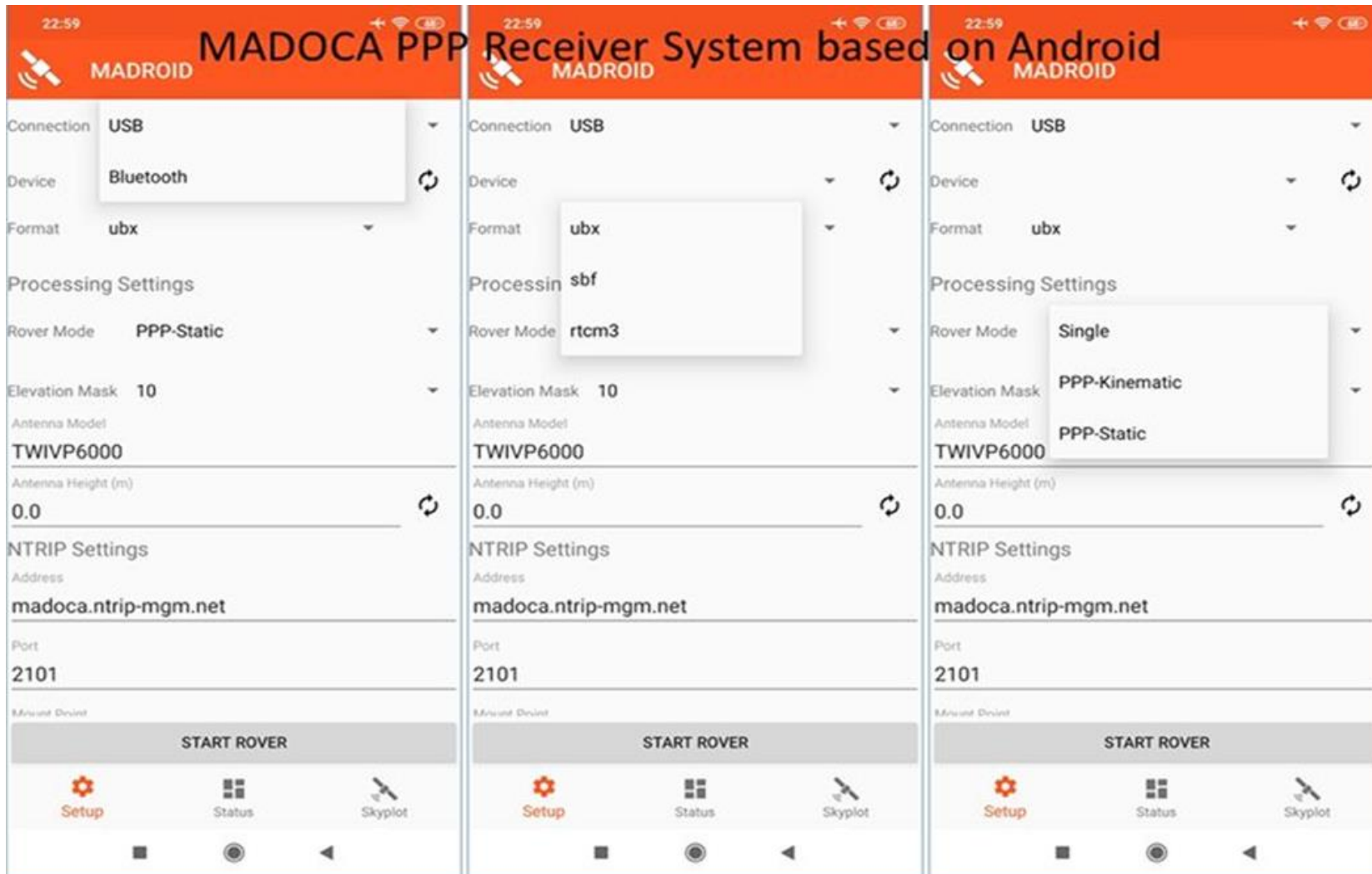

Type C: MADROID / MADOCA PPP based on Android Dual Frequency Receiver + Online MADOCA Data

The image displays three screenshots of the MADROID application interface, which is used for MADOCA PPP based on Android. The interface is divided into three main sections: Setup, Status, and Skyplot.

Left Screenshot (Setup): Shows configuration options for the receiver. The connection is USB, the device is a u-blox GNSS receiver, and the format is ubx. Processing settings include a PPP-Static rover mode, an elevation mask of 10, and an antenna model of TWIVP6000. NTRIP settings are configured with the address madoca.ntrip-mgm.net and port 2101. The mount point is MDC0. A 'START ROVER' button is visible at the bottom.

Middle Screenshot (Status): Displays real-time data and a skyplot. The UTC time is 05:27:17. Location coordinates are Latitude: 35.90202657° N, Longitude: 139.93857286° E, and Orthometric Height: 21.385m. The speed is 0.15 km/hr, and the fix type is PPP. There are 13 satellites in view and 13 in use. The PDOP is 3.4, HDOP is 1.8, and VDOP is 3.0. The skyplot shows the distribution of satellites in the sky. A bar chart at the bottom indicates the signal strength of the satellites.

Right Screenshot (Recording): Shows recording options. The date is Dec 25, 2019, and the time is 05:34:17. The location coordinates are Latitude: 35.90202310°, Longitude: 139.93857932°, X: 54N 404216.762m E, and Y: 54N 3973601.765m N. The Orthometric Height is 21.884m, and the fix type is PPP. The speed is 0.11 km/hr, HDOP is 1.9, VDOP is 3.0, and PDOP is 3.5. There are 13 satellites in view and 13 in use. The latitude error is 0.191m, longitude error is 0.171m, and altitude error is 0.104m. Recording options for NMEA (2019_12_25_14_28_19.txt, 201KB) and UBX (2019_12_25_14_28_19.ubx, 1MB) are shown. A 'STOP RECORDING' button is visible at the bottom.

Position Data from MADOCA PPP

We walked straight along the concrete tiles (30cmx30cm) and PPP results showed perfect straight line. Accuracy is about 15cm.

Receiver : F9 + Online MADOCA Correction Data

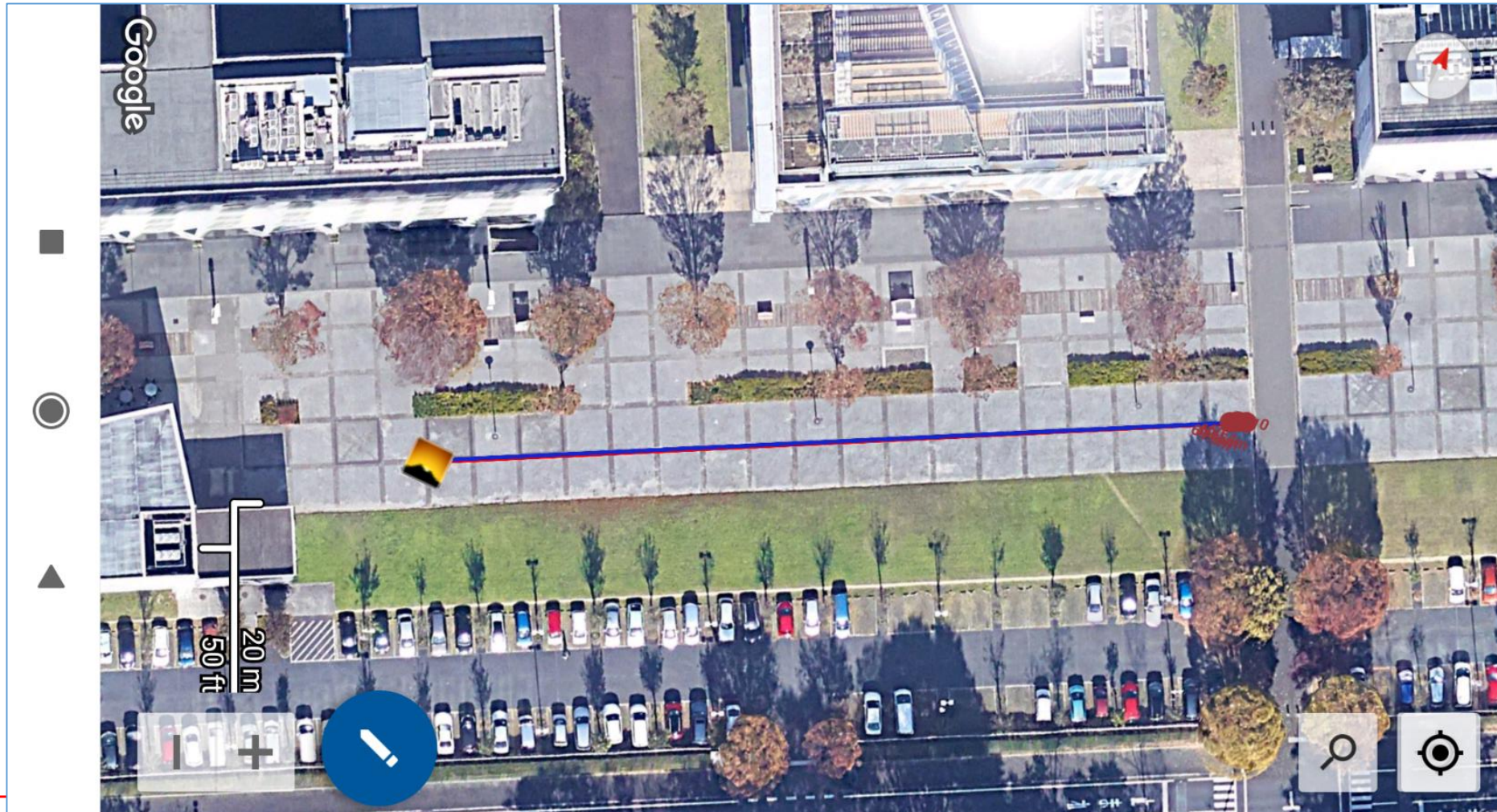

Output from MADOCA PPP Device: RaspberryPi

MADOCA PPP Observation

The image displays two side-by-side screenshots of the MADDOCA PPP Observation software interface. Both windows are titled 'MainWindow' and have standard Windows window controls (minimize, maximize, close).

Left Screenshot (Configuration):

- Connection Tab:** Contains three sections:
 - Rover:** Radio buttons for 'RX' (unselected) and 'Online' (selected). A 'Setup' button is to the right.
 - Correction:** Radio buttons for 'DX' (unselected) and 'Online (MADOCA)' (selected). A 'Setup' button is to the right.
 - Processing Mode:** Radio buttons for 'PPP-Static' (selected) and 'PPP-Kinematic' (unselected). A large 'Start/Stop' button is at the bottom.
- Status:** A 'Connected' indicator is shown at the bottom left.
- Record Tab:** An 'Exit' button is located at the top right.

Right Screenshot (Status):

- Connection Tab:** A 'Device' dropdown menu is set to 'OS'. Below it, the following information is displayed:
 - Solution: 2019-12-27_125516.nmea(482304)
 - Rover: 2019-12-27_125516.ubx(3896320)
 - Correction: 2019-12-27_125516.rtc3(1553408)
- Status:** A 'Record On/Off' button is present.
- Record Tab:** A green progress bar is visible at the bottom right, indicating recording is active.
- Exit:** An 'Exit' button is located at the top right.

Connection Status Record Exit

Time 2019-12-27 12:52:43
 Latitude 35.90305269°
 Longitude 139.93930937°
 Altitude 94.914m
 Solution PPP
 Lat Error 5.095m
 Lon Error 4.413m
 Alt Error 3.702m

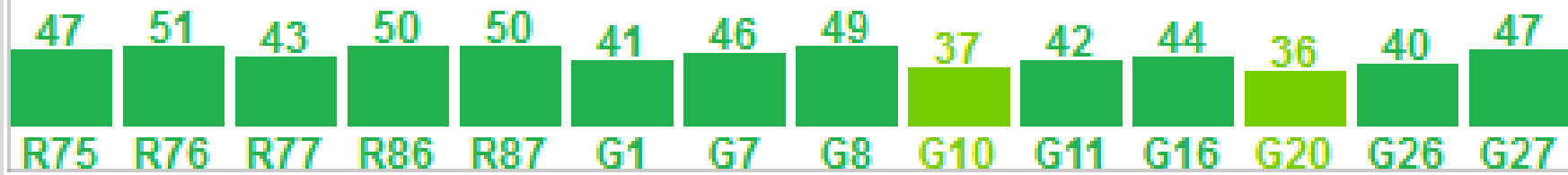
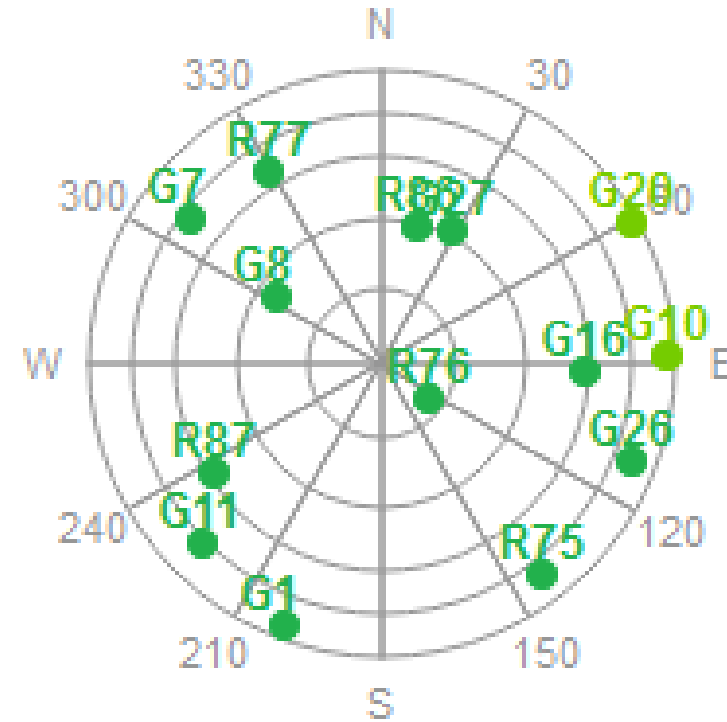

Connected

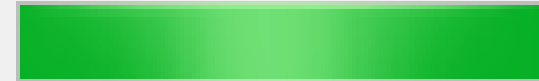

Connection

Status

Record

Exit

Time 2019-12-27 12:52:51
 Latitude 35.90305439°
 Longitude 139.93930858°
 Altitude 92.701m
 Solution PPP
 Lat Error 3.121m
 Lon Error 2.647m
 Alt Error 2.307m

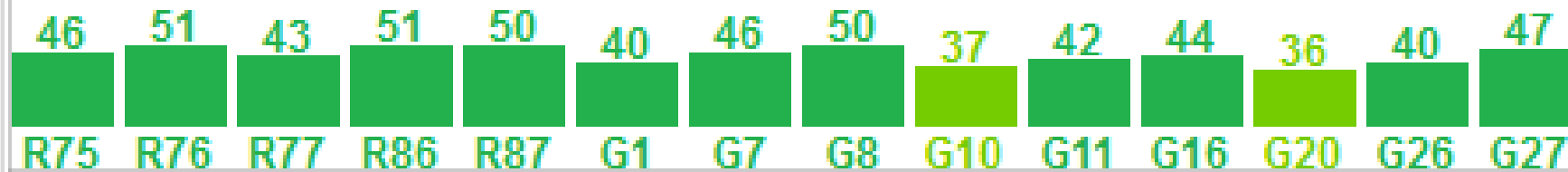
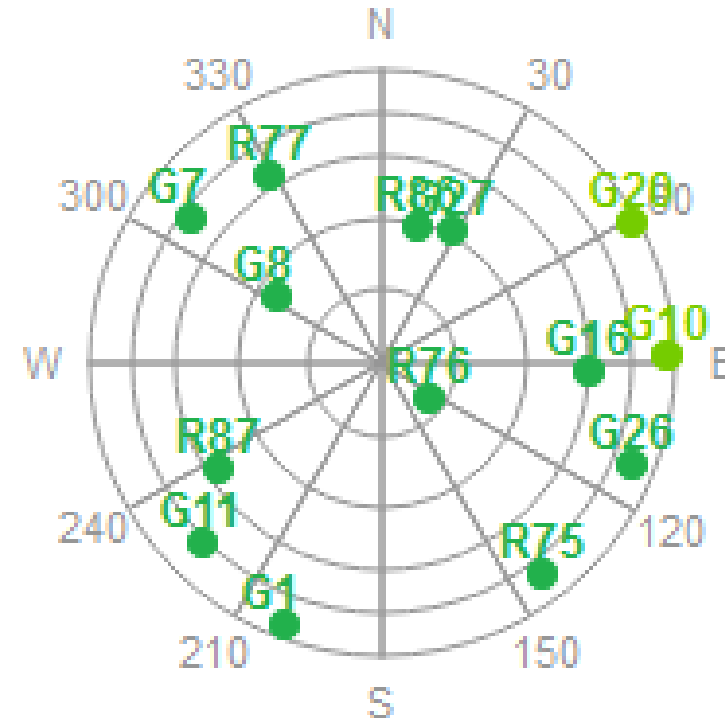

Connected



Connection Status Record Exit

Time 2019-12-27 12:52:59
 Latitude 35.90304378°
 Longitude 139.93930210°
 Altitude 93.777m
 Solution PPP
 Lat Error 2.328m
 Lon Error 1.949m
 Alt Error 1.722m

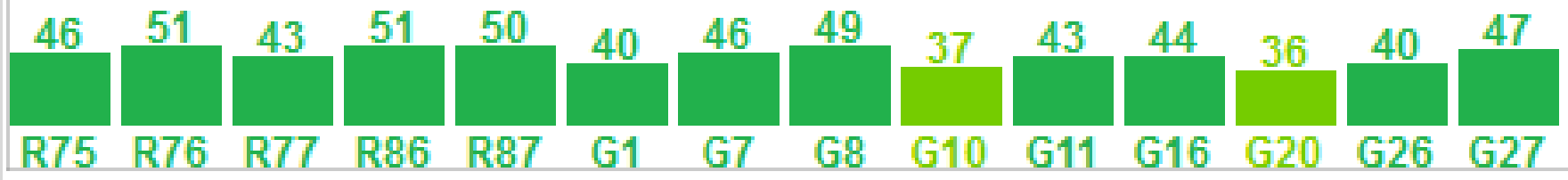
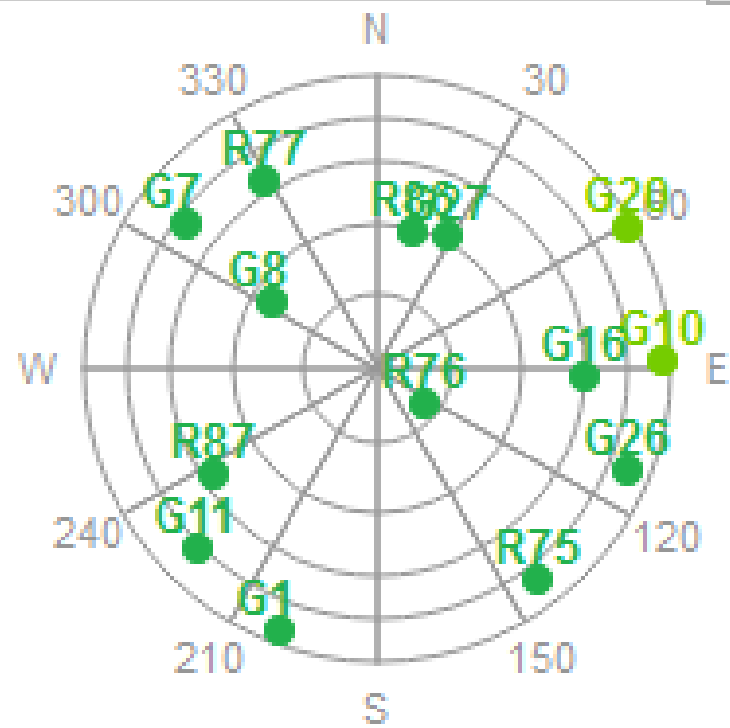

Connected

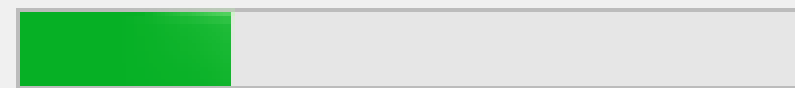

Connection Status Record Exit

Time 2019-12-27 12:53:20
 Latitude 35.90304275°
 Longitude 139.93930592°
 Altitude 94.133m
 Solution PPP
 Lat Error 1.395m
 Lon Error 1.144m
 Alt Error 1.011m

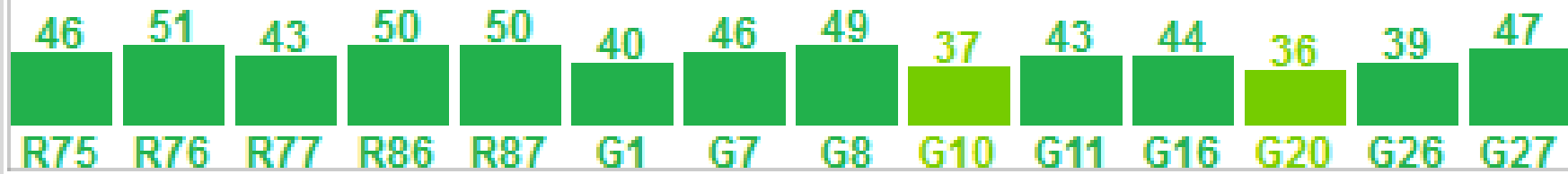
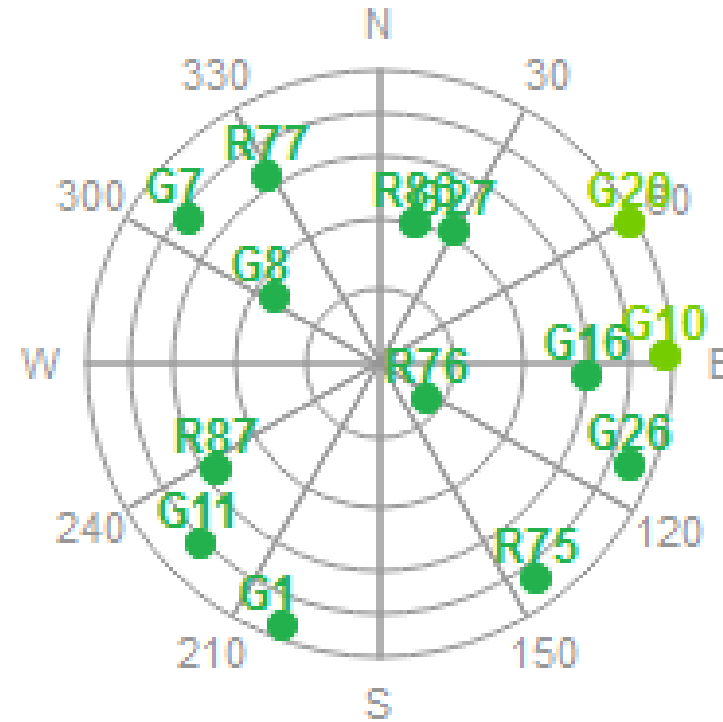

Connected



Connection

Status

Record

Exit

Time 2019-12-27 12:53:35
 Latitude 35.90303716°
 Longitude 139.93930085°
 Altitude 93.859m
 Solution PPP
 Lat Error 1.078m
 Lon Error 0.875m
 Alt Error 0.769m

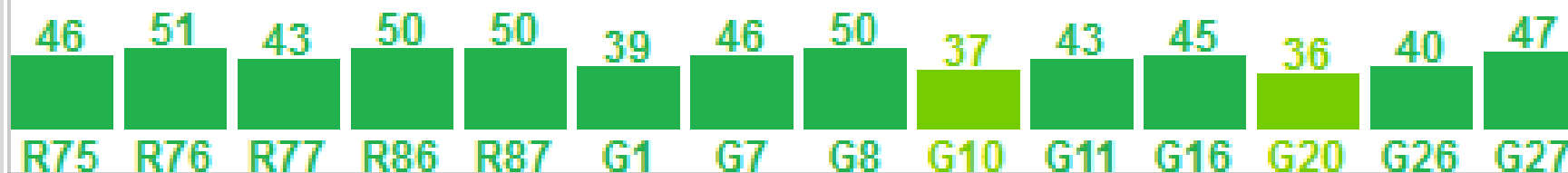
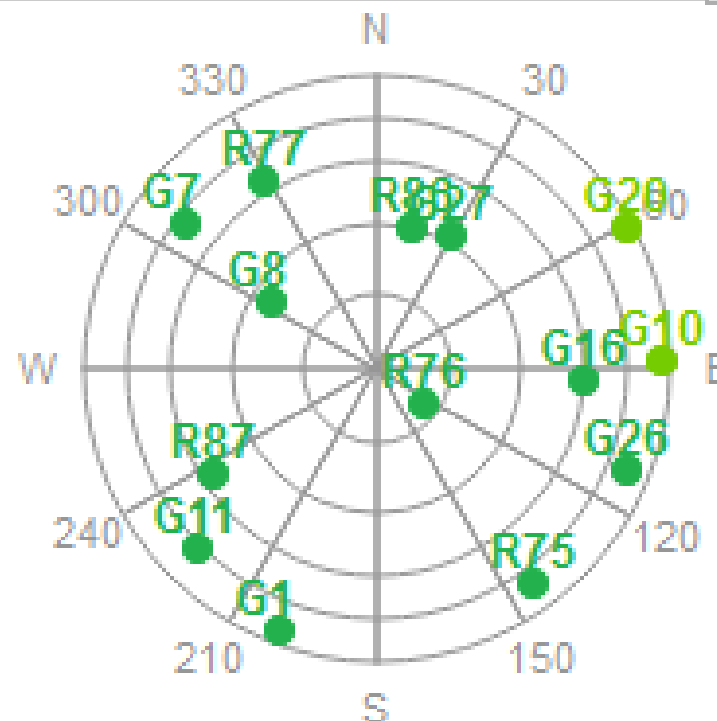

Connected



Connection Status Record Exit

Time 2019-12-27 12:53:47
 Latitude 35.90303925°
 Longitude 139.93930080°
 Altitude 93.329m
 Solution PPP
 Lat Error 0.911m
 Lon Error 0.736m
 Alt Error 0.644m

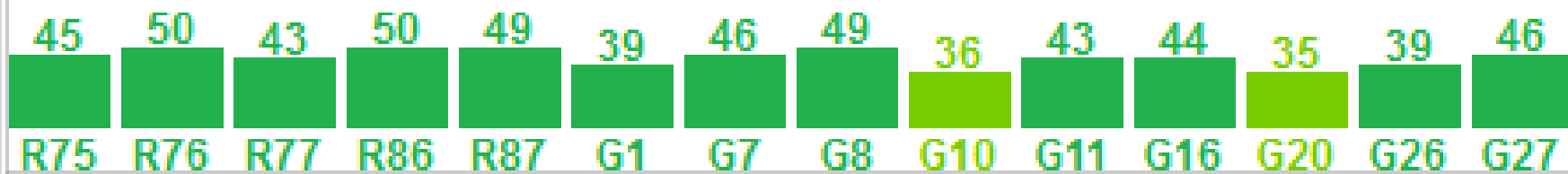
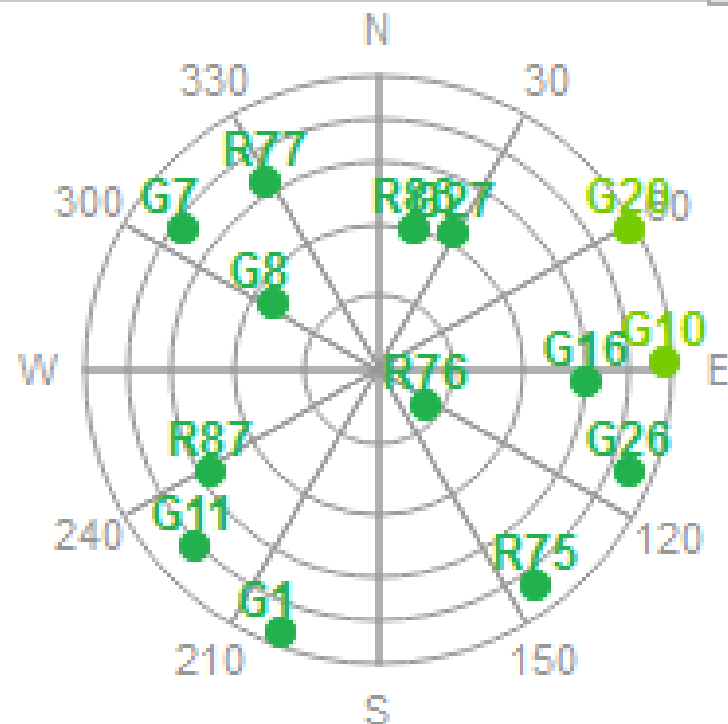

Connected

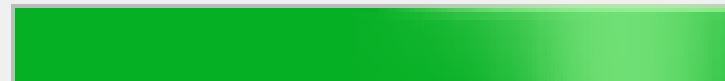

Connection Status Record Exit

Time 2019-12-27 12:54:57
 Latitude 35.90304348°
 Longitude 139.93930513°
 Altitude 93.079m
 Solution PPP
 Lat Error 0.475m
 Lon Error 0.374m
 Alt Error 0.330m

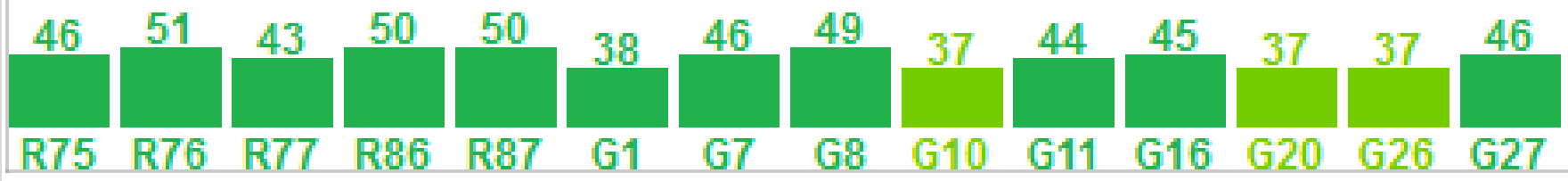
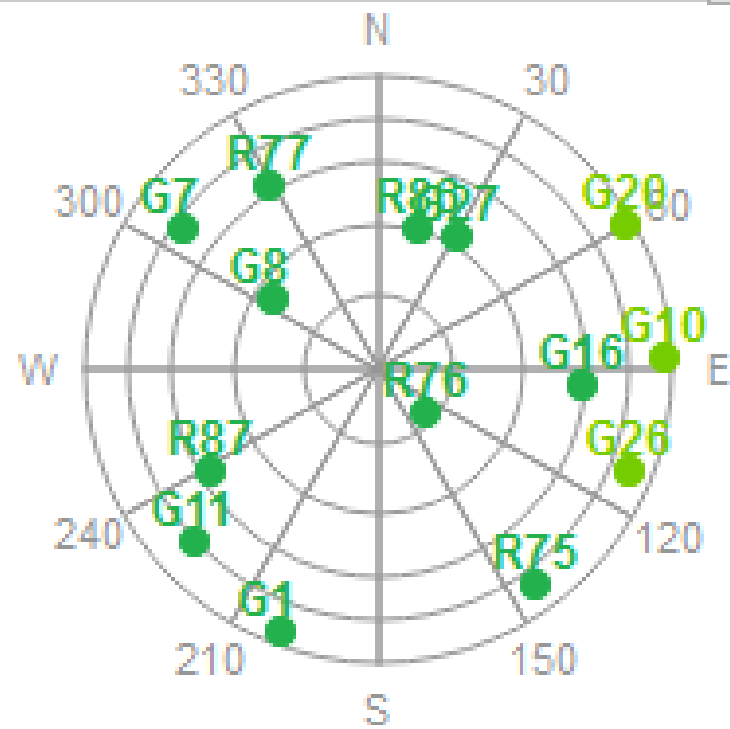

Connected



Connection

Status

Record

Exit

Time 2019-12-27 12:55:41
 Latitude 35.90304133°
 Longitude 139.93930448°
 Altitude 93.445m
 Solution PPP
 Lat Error 0.363m
 Lon Error 0.277m
 Alt Error 0.244m

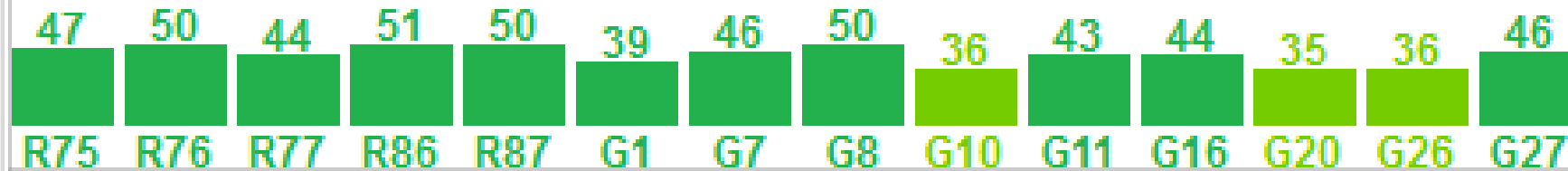
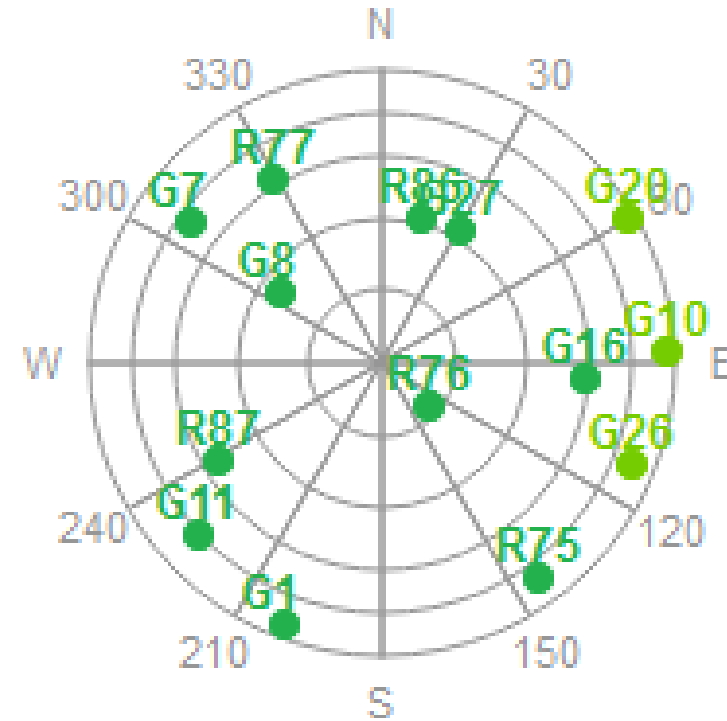

Connected

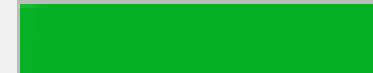

Connection Status Record Exit

Time 2019-12-27 12:57:17
 Latitude 35.90304144°
 Longitude 139.93930387°
 Altitude 93.731m
 Solution PPP
 Lat Error 0.238m
 Lon Error 0.169m
 Alt Error 0.145m

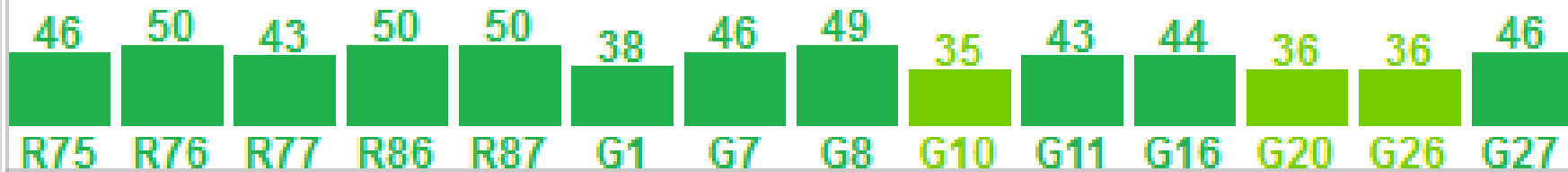
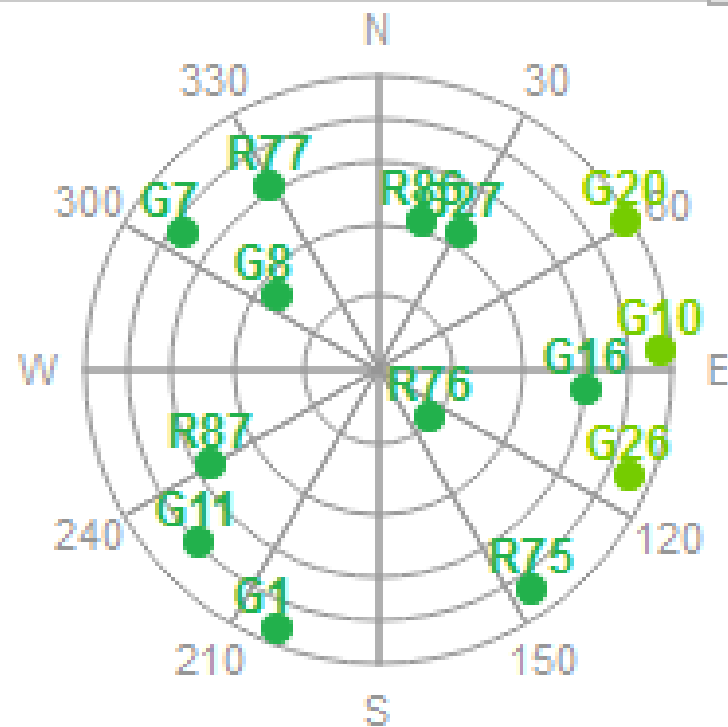

Connected

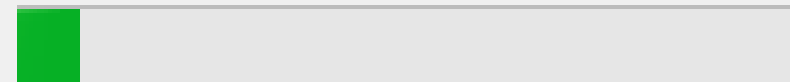

Connection Status Record Exit

Time 2019-12-27 12:58:37
 Latitude 35.90304107°
 Longitude 139.93930415°
 Altitude 93.662m
 Solution PPP
 Lat Error 0.182m
 Lon Error 0.124m
 Alt Error 0.104m

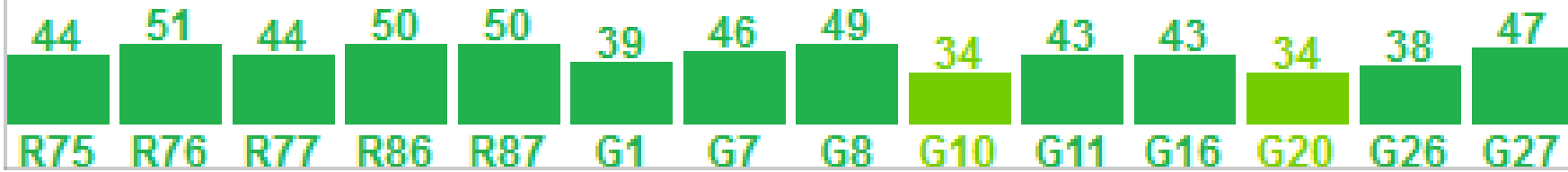
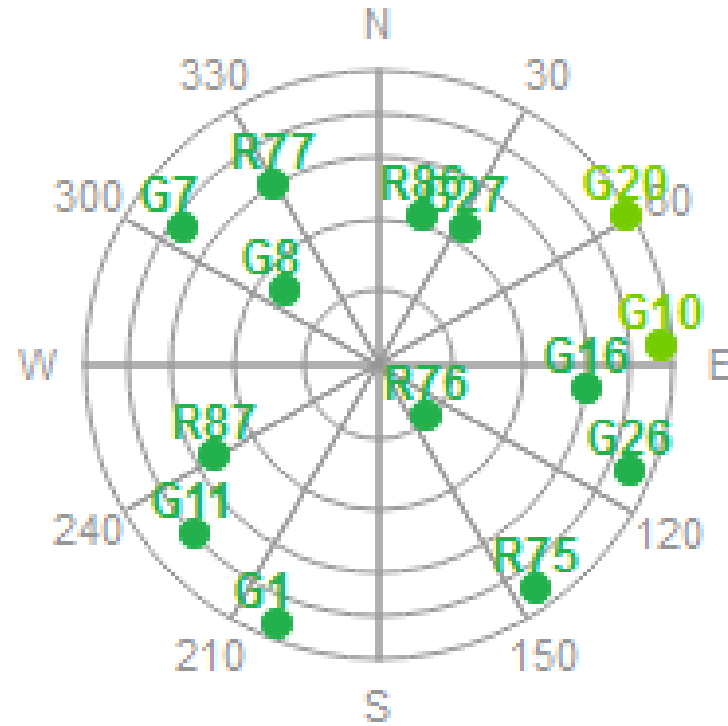

Connected



Connection Status Record Exit

Time 2019-12-27 12:59:57
 Latitude 35.90304104°
 Longitude 139.93930405°
 Altitude 93.629m
 Solution PPP
 Lat Error 0.146m
 Lon Error 0.096m
 Alt Error 0.079m

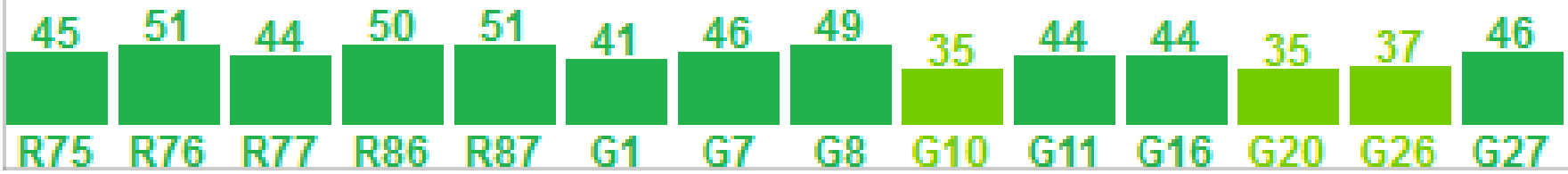
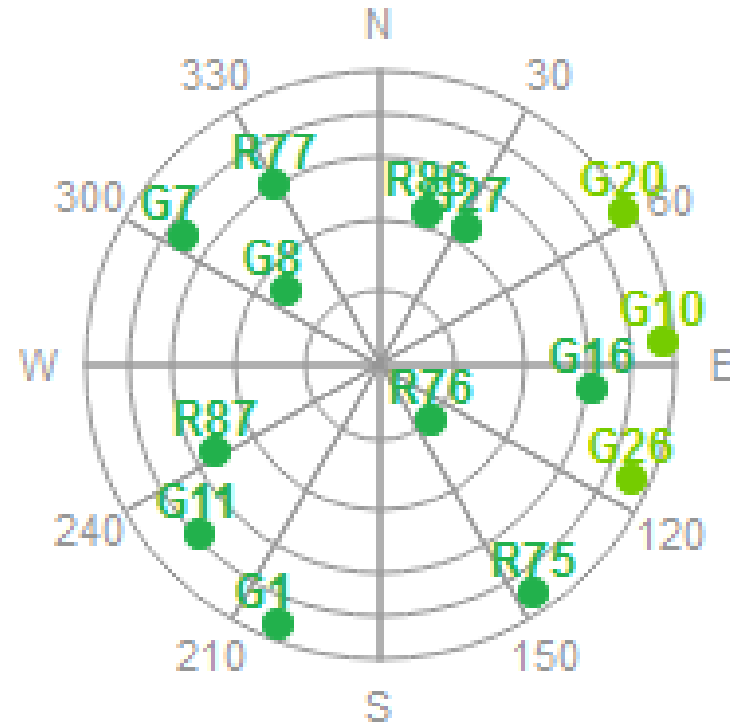

Connected

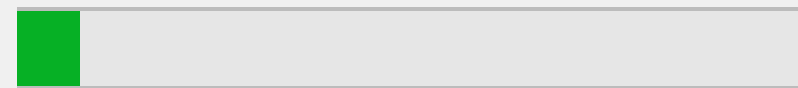

Connection Status Record Exit

Time 2019-12-27 13:00:39
 Latitude 35.90304101°
 Longitude 139.93930435°
 Altitude 93.589m
 Solution PPP
 Lat Error 0.131m
 Lon Error 0.086m
 Alt Error 0.070m

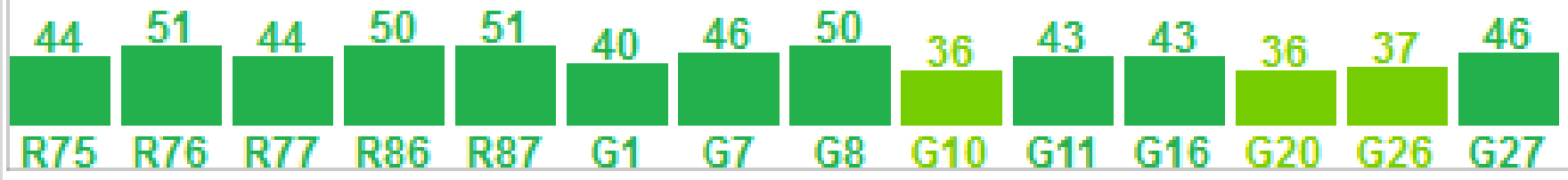
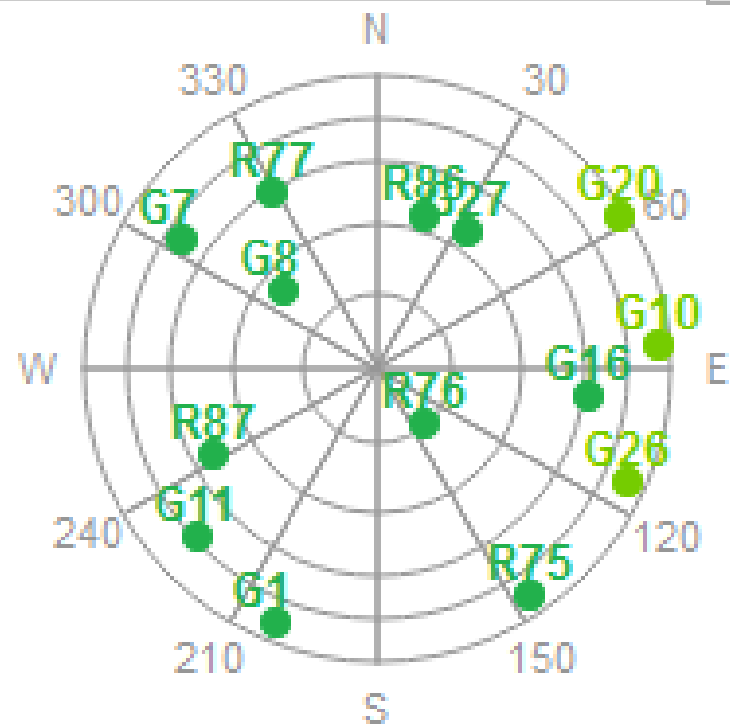

Connected

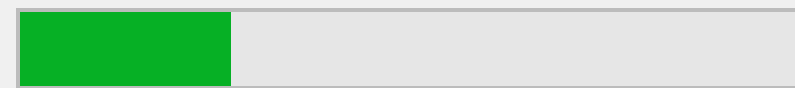

Connection Status Record Exit

Time 2019-12-27 13:02:34
 Latitude 35.90304072°
 Longitude 139.93930462°
 Altitude 93.549m
 Solution PPP
 Lat Error 0.101m
 Lon Error 0.065m
 Alt Error 0.052m

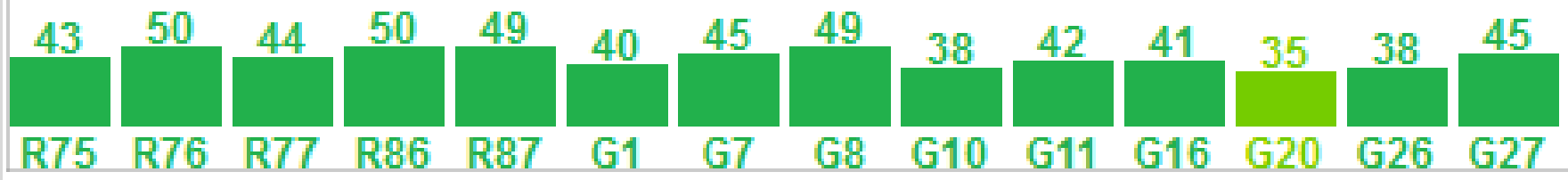
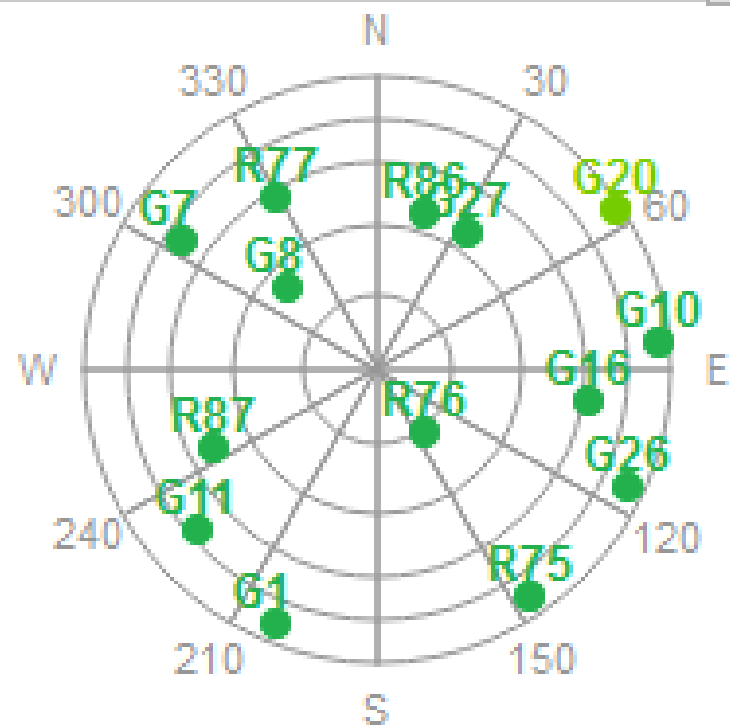

Connected



Connection Status Record Exit

Time 2019-12-27 13:04:14
 Latitude 35.90304051°
 Longitude 139.93930613°
 Altitude 93.590m
 Solution PPP
 Lat Error 0.083m
 Lon Error 0.053m
 Alt Error 0.042m

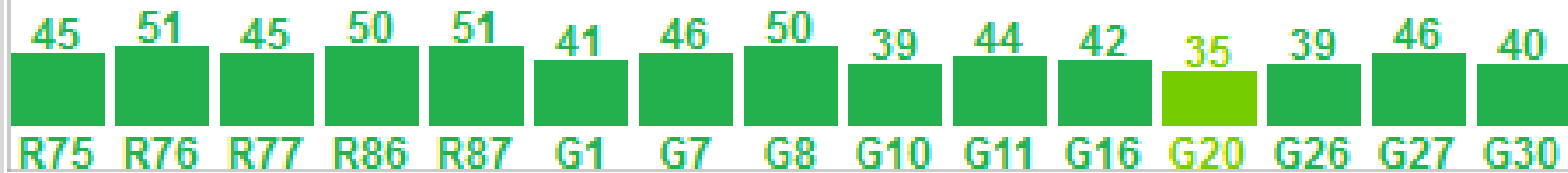
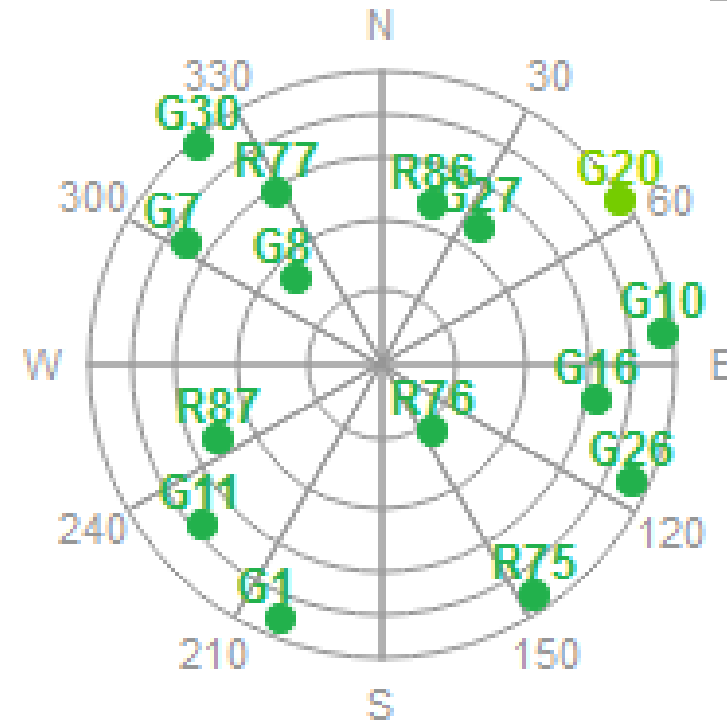

Connected



Connection Status Record Exit

Time 2019-12-27 13:07:13
 Latitude 35.90304006°
 Longitude 139.93930672°
 Altitude 93.619m
 Solution PPP
 Lat Error 0.062m
 Lon Error 0.039m
 Alt Error 0.031m

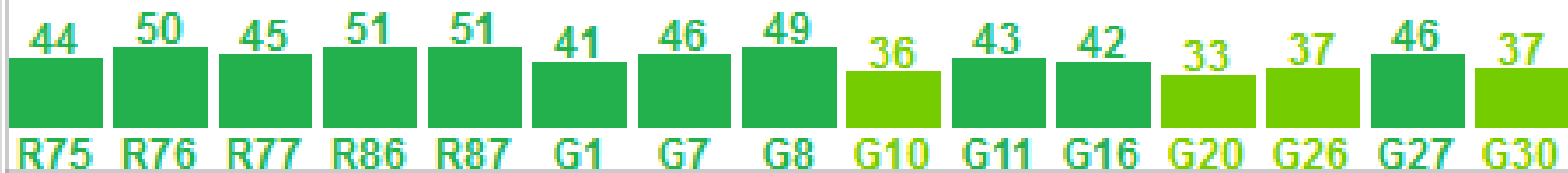
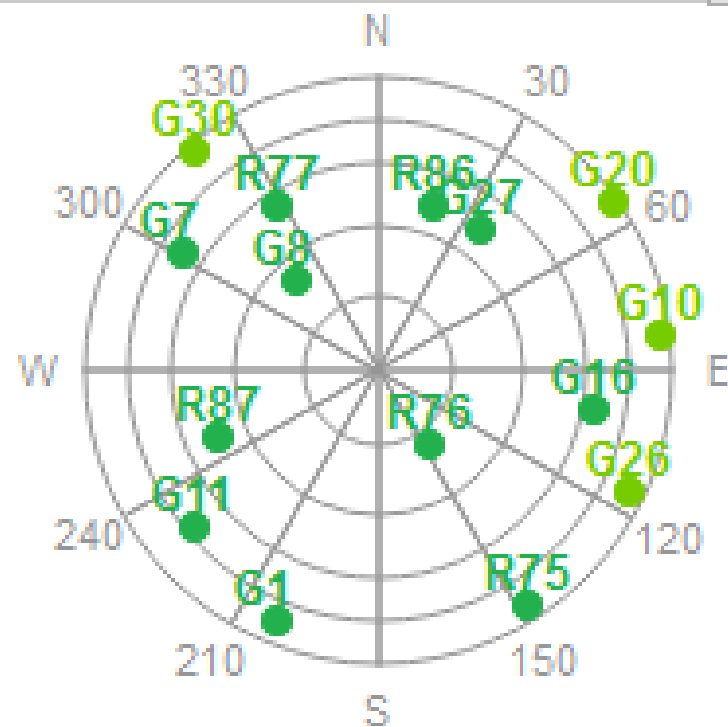

Connected



Connection

Status

Record

Exit

Time 2019-12-27 13:08:01

Latitude 35.90304015°

Longitude 139.93930647°

Altitude 93.592m

Solution PPP

Lat Error 0.058m

Lon Error 0.036m

Alt Error 0.030m

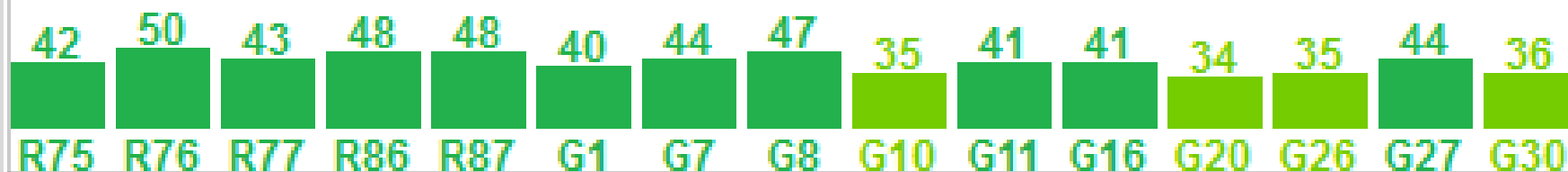
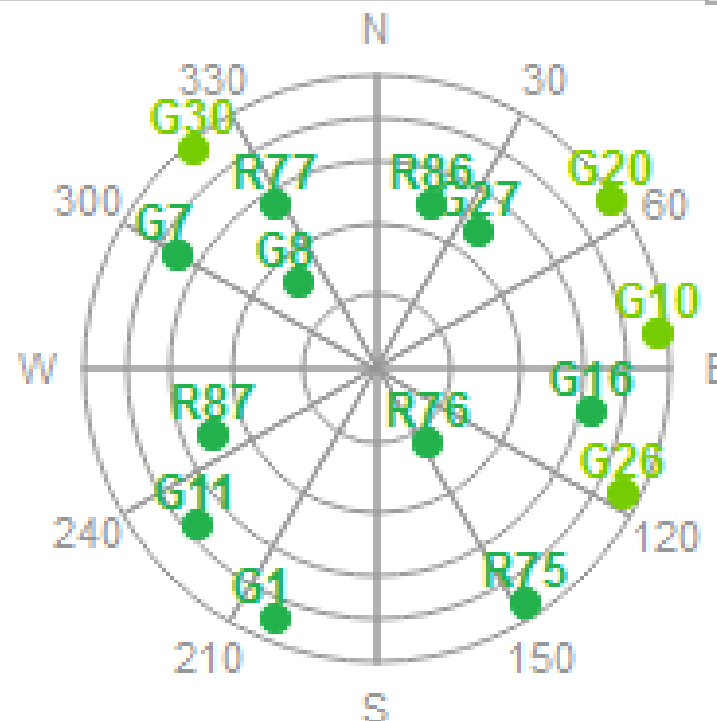

Connected



Connection Status Record Exit

Time 2019-12-27 13:29:13
 Latitude 35.90304023°
 Longitude 139.93930615°
 Altitude 93.494m
 Solution PPP
 Lat Error 0.017m
 Lon Error 0.010m
 Alt Error 0.009m

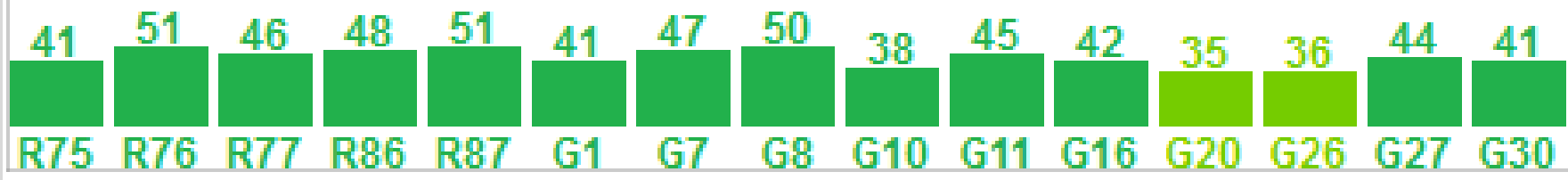
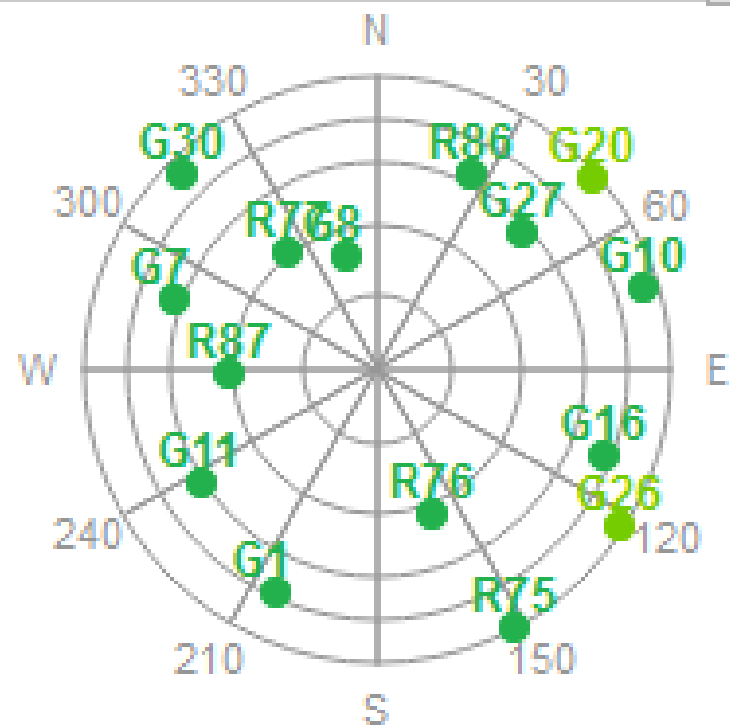

Connected

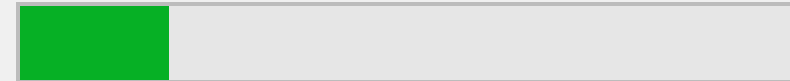

MADOCA PPP at Kashiwa Campus

MainWindow

Connection Status Record Exit

Rover
 RX Online Setup

Correction
 DX Online (MADOCA) Setup

Processing Mode
 PPP-Static PPP-Kinematic

Start/Stop

Connected

MainWindow

Connection Status Record Exit

Time 2020-03-17 03:22:25
 Latitude 35.90305334°
 Longitude 139.93929893°
 Altitude 91.388m
 Solution PPP
 Lat Error 0.868m
 Lon Error 0.966m
 Alt Error 0.685m

Station Distribution Plot (North, South, East, West):
 R71, R61, G11, R6, G1, R8, G2, R7, G3, R8, G2, R8, G2, R8, G2

Signal Strength Bar Chart:
 44 47 44 44 48 49 49 31 49 46 46 43 38 35 47
 G29 G31 G32 R65 R66 R75 R76 R84 R85 R86 G14 G16 G21 G25 G26

Connected

MainWindow

Connection Status Record Exit

Device Windows

Solution 2020-03-17_032112.nmea(10661888)
 Rover 2020-03-17_032112.ubx(95114240)
 Correction 2020-03-17_032112.ubx(90121216)

Record On/Off

Connected

MADOCA PPP at Kashiwa Campus

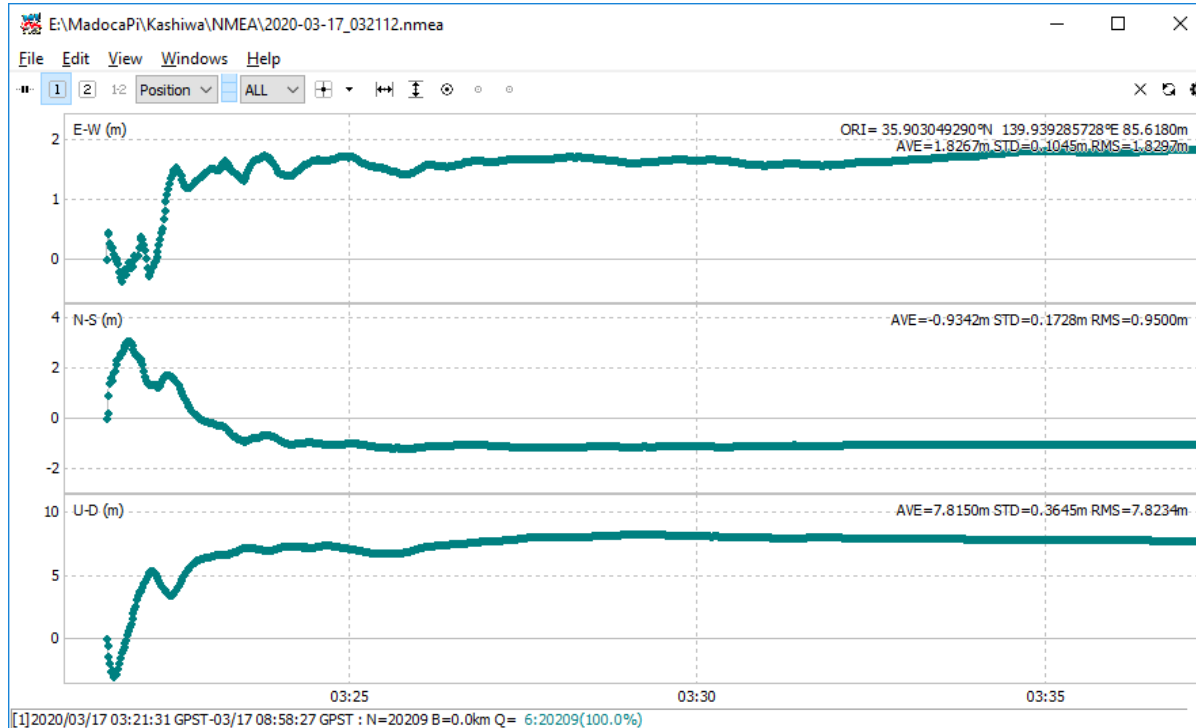

	Measured Values	True Values	Difference meter
LAT	35.90304079	35.90304065	-0.02
LON	139.93930587	139.93930614	0.03
Ht	93.446	93.463	0.02

MADOCA PPP at Kashiwa Campus

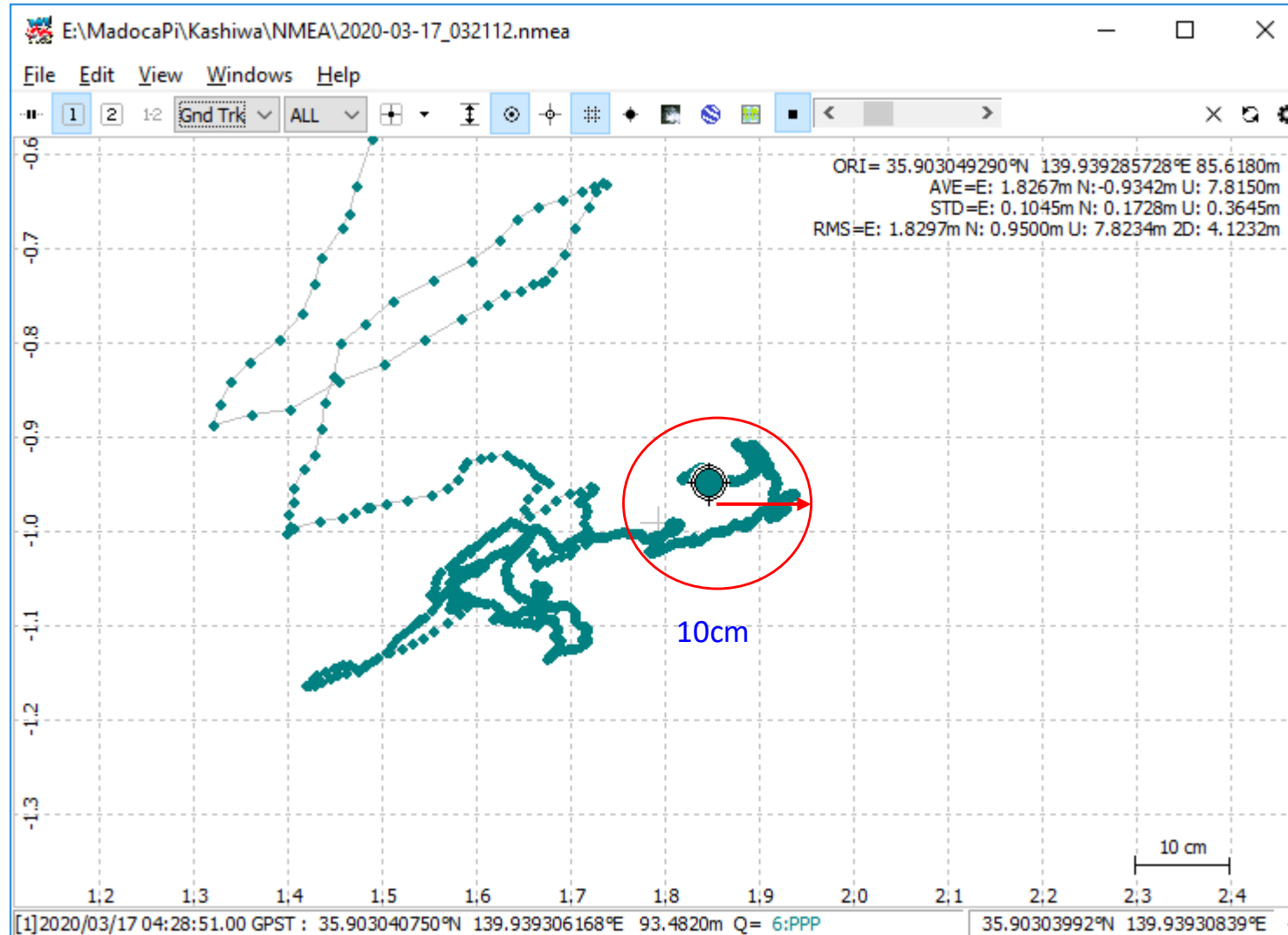

MADOCA PPP Observation in Cairo, Egypt

Precise Measurement using Low-Cost Receiver System for High-Accuracy based on QZSS MADOCA Correction Data

	Measured Values	True Values	Difference meter
LAT			0.4521
LON			0.2651
Ht	52.537	51.216	0.279*

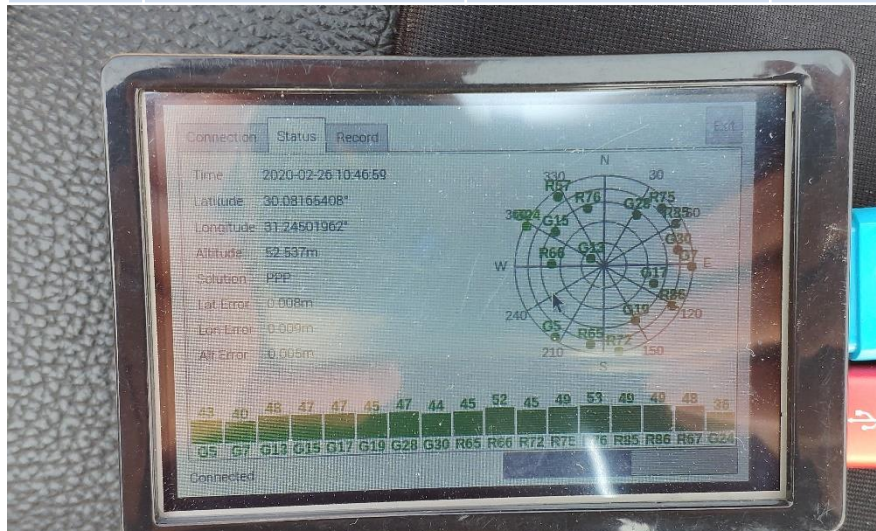

MADOCA PPP measurement display on RaspberryPi device.

Difference = (True – Measured) / 1 deg about 110Km

*Antenna Height is 1.6m, GCP Height is 52.537-1.6 = 50.937m



Setting MADOCA low-cost receiver system in RaspberryPi device.

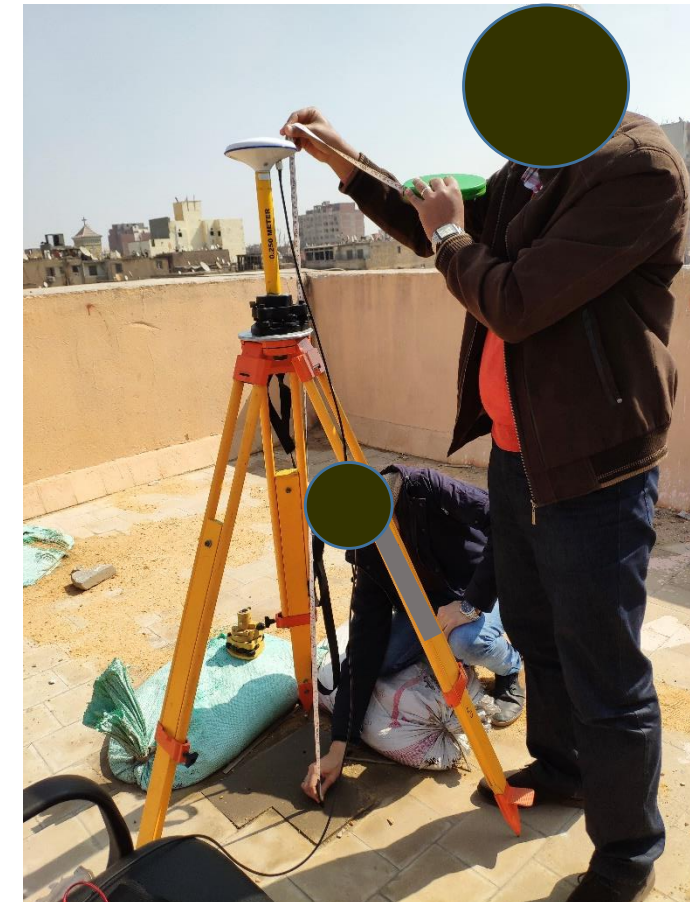

Measuring antenna height from the ground control point for precise measurement.

Precise Measurement using Low-Cost Receiver System for High-Accuracy based on QZSS MADOCA Correction Data

