

Introduction to Global Navigation Satellite System (GNSS) Module: 1

Dinesh Manandhar

Center for Spatial Information Science

The University of Tokyo

Contact Information: dinesh@csis.u-tokyo.ac.jp

Module 1: Course Contents

- Introduction
- How GNSS Works?
- GPS Signal Structure
- GNSS Systems
 - GPS
 - GLONASS
 - GALILEO
 - BEIDOU
 - QZSS
 - IRNSS
- Multi-GNSS

Fundamental Problem

- How to know my location precisely ?
 - In any condition
 - At any time
 - Everywhere on earth (at least outdoors!)
- How to navigate to the destination?
 - Guidance or Navigation
- How to synchronize time globally?
 - Mobile phones
 - Financial Institutes

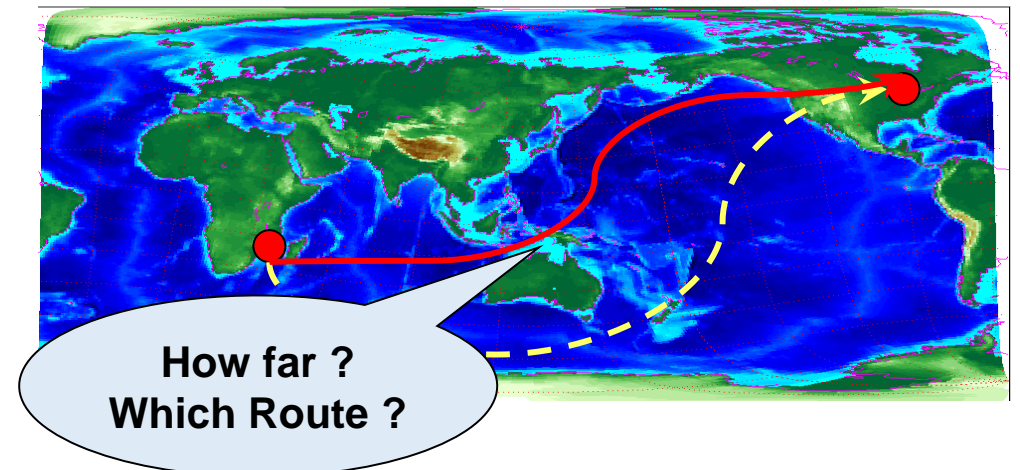
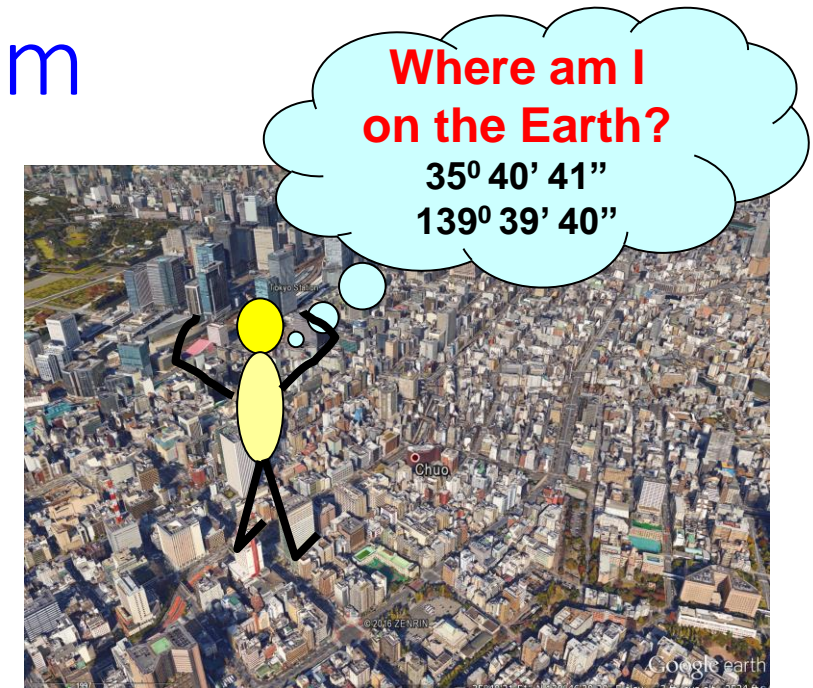

Navigation Types

- Landmark-based Navigation
 - Stones, Trees, Monuments
 - Limited Local use
- Celestial-based Navigation
 - Stars, Moon
 - Complicated, Works only at Clear Night
- Sensors-based Navigation
 - Dead Reckoning
 - Gyroscope, Accelerometer, Compass, Odometer
 - Complicated, Errors accumulate quickly
- Radio-based Navigation
 - LORAN, OMEGA
 - Subject to Radio Interference, Jamming, Limited Coverage
- Satellite-based Navigation or GNSS
 - TRANSIT, GPS, GLONASS, GALILEO, QZSS, BEIDOU (COMPASS), IRNSS
 - Global, Difficult to Interfere or Jam, High Accuracy & Reliability

What is GNSS?

Global Navigation Satellite System (GNSS) is the standard generic term for all navigation satellites systems like GPS, GLONASS, GALILEO, BeiDou, QZSS, NAVIC.

- Global Constellation

- GPS USA
- GLONASS, Russia
- Galileo, Europe
- BeiDou (COMPASS) / BDS, China

- Regional Constellation

- QZSS, Japan
- NAVIC (IRNSS), India

Satellite Based Augmentation System (SBAS)

- Satellite Based Augmentation System (SBAS) are used to augment GNSS Data
 - Provide Higher Accuracy and Integrity
 - Some correction data like satellite orbit, satellite clock and atmospheric data are broadcasted from communication satellites
 - Used by ICAO for Aviation
- SBAS Service Providers
 - WAAS, USA
 - MSAS, Japan
 - EGNOS, Europe
 - GAGAN, India
 - SDCM, Russia
 - Nigeria
 - Korea (Also navigation system)
 - Australia

Determine the Distance using Radio Wave

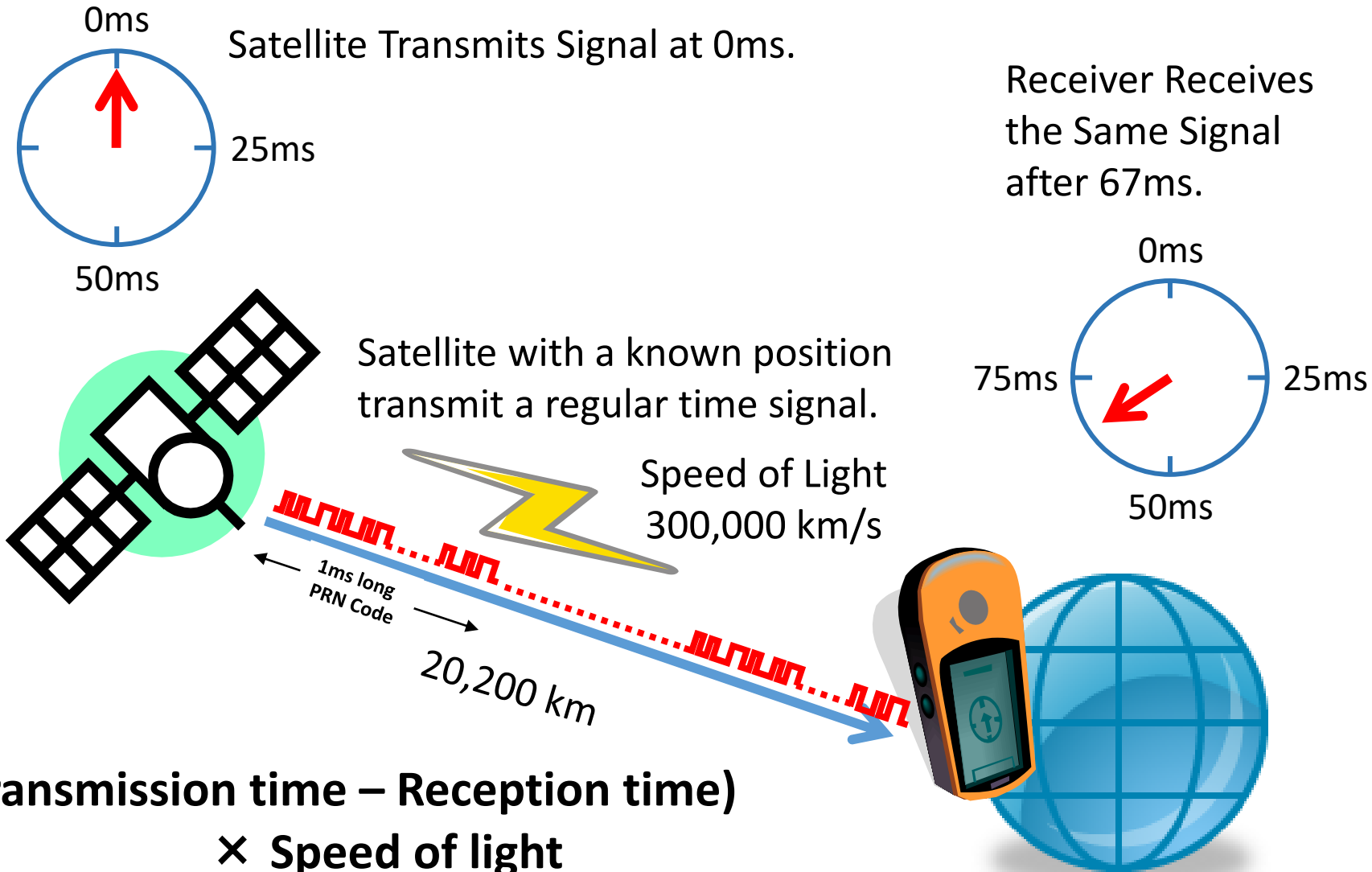

Principle of Satellite-based Navigation

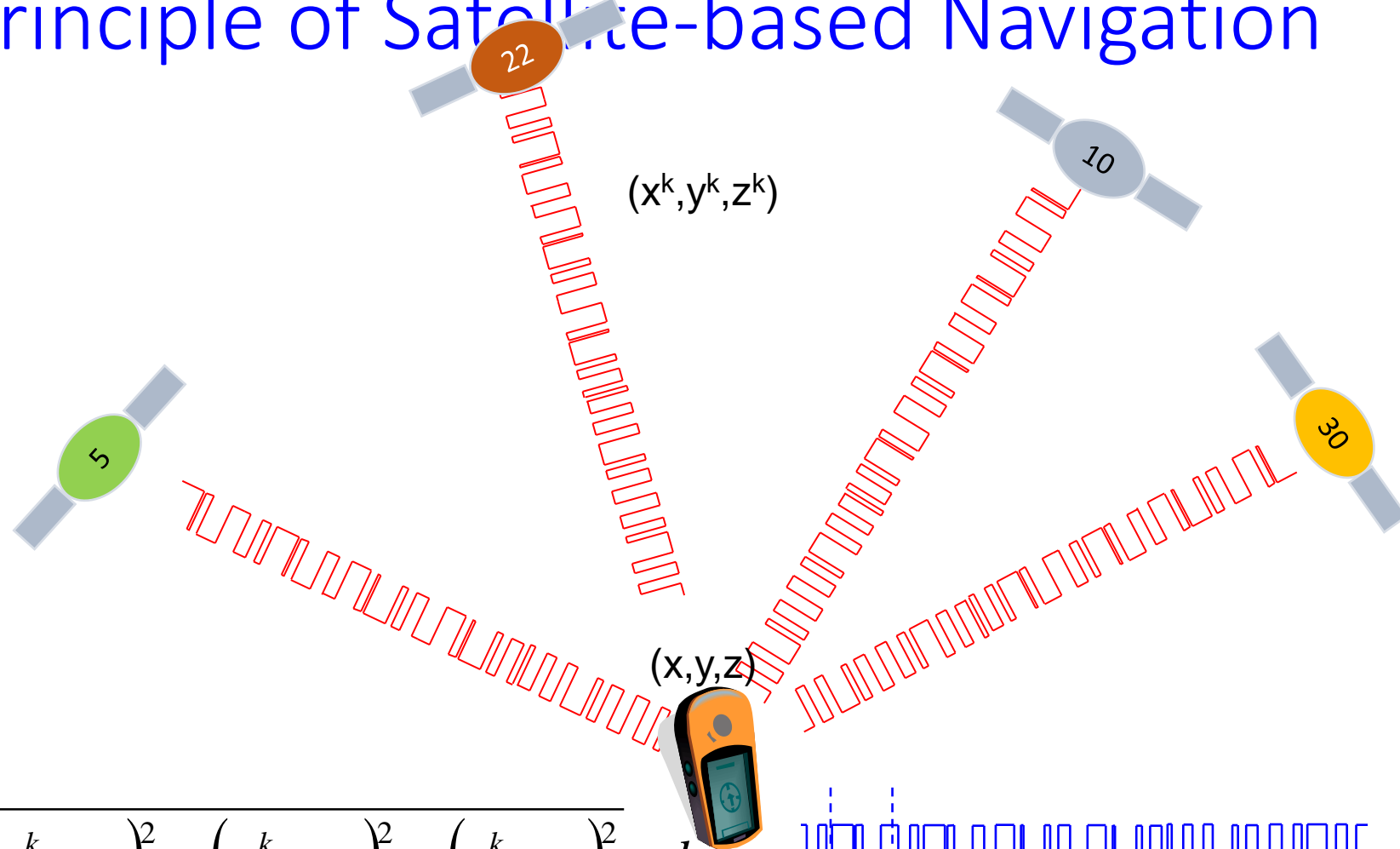

$$\rho^k = \sqrt{(x^k - x)^2 + (y^k - y)^2 + (z^k - z)^2} - b$$

If $k \geq 4$, solve for x , y , z and clock bias, b

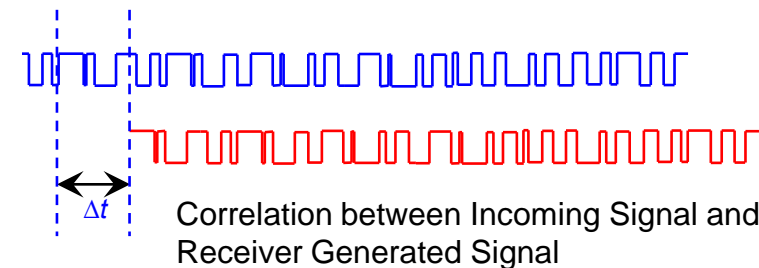

GNSS Requirements

- GNSS needs a common time system.
 - Each GNSS satellite has atomic clocks.
 - How about user receivers?
- The signal transmission time has to be measurable.
 - Each GNSS satellite transmits a unique digital signature, which consists an apparent random sequence, PRN Code
 - A Time Reference is transmitted using the Navigation Message
- Each signal source has to be distinguishable.
 - GNSS utilizes code division multiple access (CDMA) or frequency division multiple access (FDMA).
- The position of each signal source must be known.
 - Each satellite sends its orbit data using the Navigation Message
 - Orbit Data: Almanac and Ephemeris

Characteristics of GNSS Signals

- GNSS Signals have basically three types of signals
 - Carrier Signal
 - PRN Code (C/A Code)
 - Navigation Data
- All GNSS Signals except GLONASS are based on CDMA
 - Only GLONASS use FDMA
 - Future Signals of GLONASS will also use CDMA
- The modulation scheme of GNSS signals
 - BPSK
 - Various versions of BOC

CDMA: Code Division Multiple Access
FDMA: Frequency Division Multiple Access
BPSK : Binary Phase Shift Keying
BOC: Binary Offset Carrier

GPS L1C/A Signal Structure

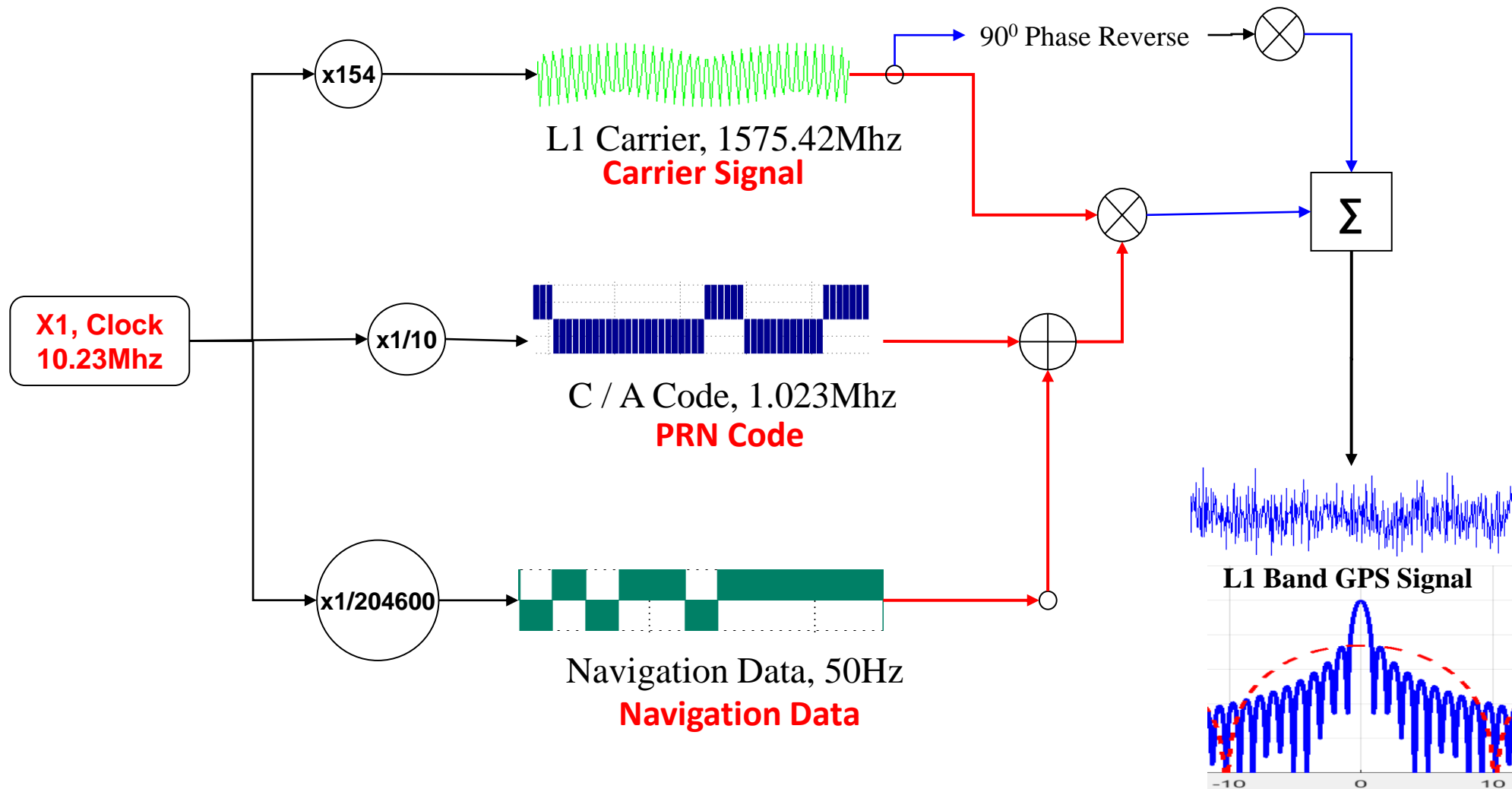

GPS L1C/A Signal Structure

- Carrier Signal
 - It defines the frequency of the signal
 - For example:
 - GPS L1 is 1575.42MHz, L2 is 1227.60MHz and L5 is 1176.45MHz
- PRN Code
 - Used to identify satellite ID in CDMA
 - Requires to modulate the data
 - Should have good auto-correlation and cross-correlation properties
- Navigation Data
 - Includes satellite orbit related data (ephemeris data)
 - Includes satellite clock related information (clock errors etc)

GPS L1C/A PRN Code Generator

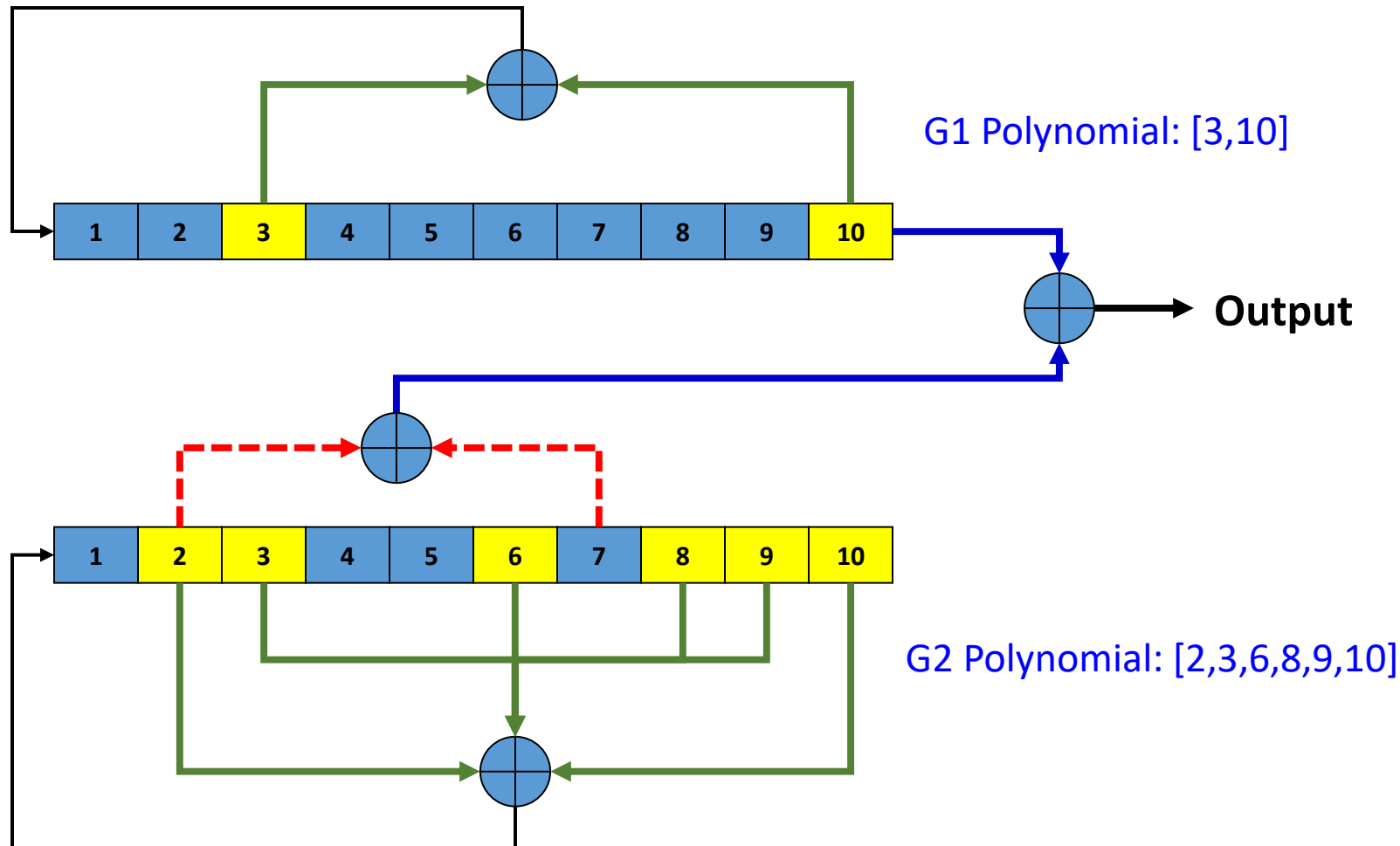

Characteristics of PRN Code

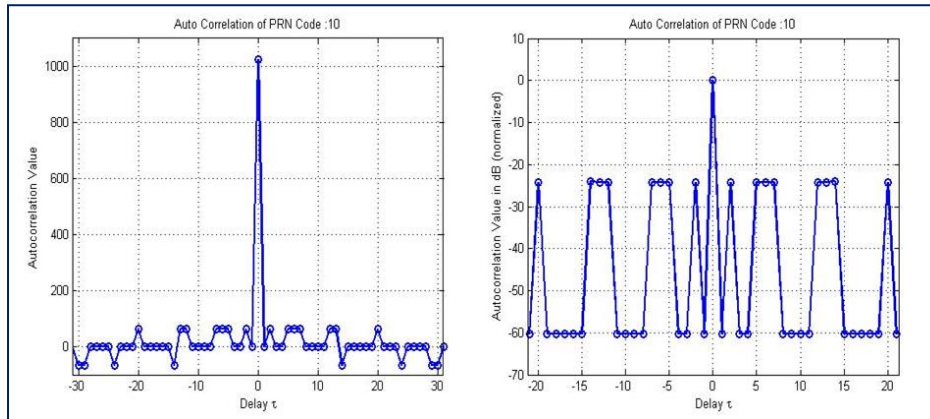

Auto-correlation: Only four values:
1023, 1, 63 or 65 (Ideal case)

- PRN codes are very uniquely designed.
- GPS and other GNSS use CDMA
 - One PRN code is assigned to one satellite.
 - In case of GPS, PRN code is 1023 bits long.
 - GLONASS is different. It uses FDMA. The same code for all satellites but different frequencies.
 - Some new signals of GLONASS also uses CDMA signals

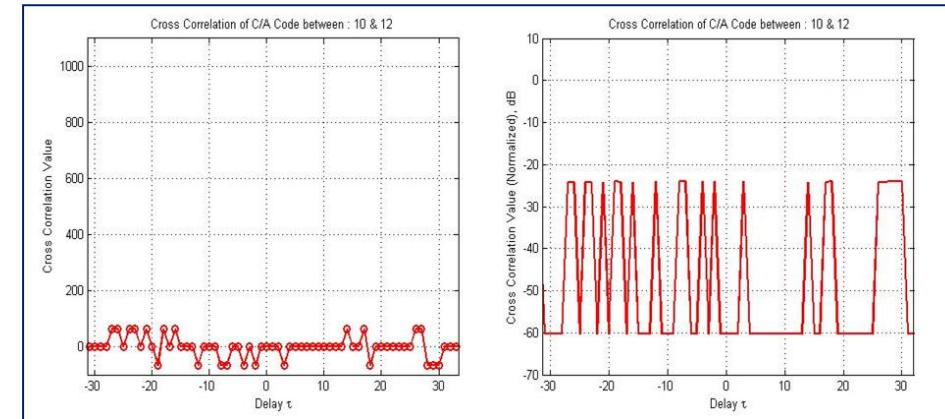

Cross-correlation: Only three values:
1, 63 or 65 (Ideal Case)

- Maximum Cross-correlation Value is -23dB.
- If any signal above this power enters a GPS receiver, it will totally block all GPS signals.
- If longer PRN code is used, receiver becomes more resistive to Jamming signal
 - But, signal processing is more complex

PRN (Pseudo Random Noise) Code

- PRN Code is a sequence of randomly distributed zeros and ones that is one millisecond long.
 - This random distribution follows a specific code generation pattern called Gold Code.
 - There are 1023 zeros or ones in one millisecond.
- Each GPS satellite transmits a unique PRN Code.
 - GPS receiver identifies satellites by its unique PRN code or ID.
- It is continually repeated every millisecond and serves for signal transit time measurement.
 - The receiver can measure where the PRN code terminated or repeated.

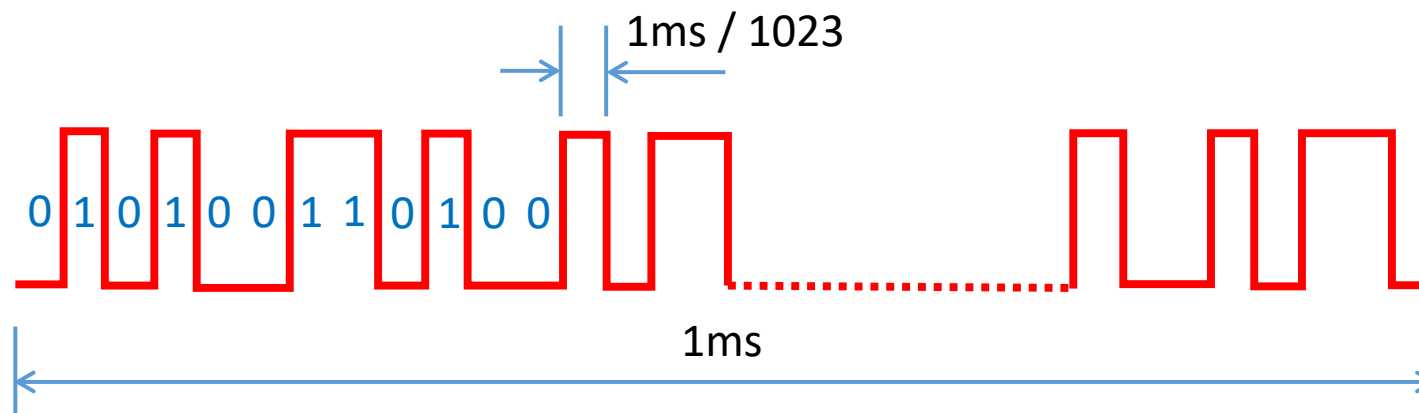

Modulation

Modulation is the process of conveying a message signal, for example a digital bit stream, into a radio frequency signal that can be physically transmitted.

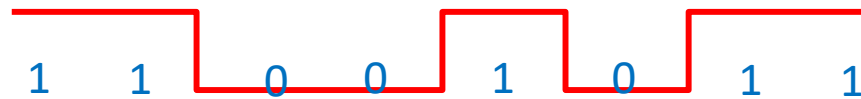

You want to transmit
this binary code

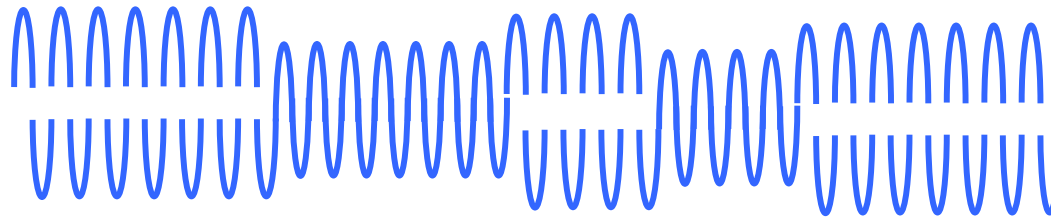

Amplitude Shift Keying

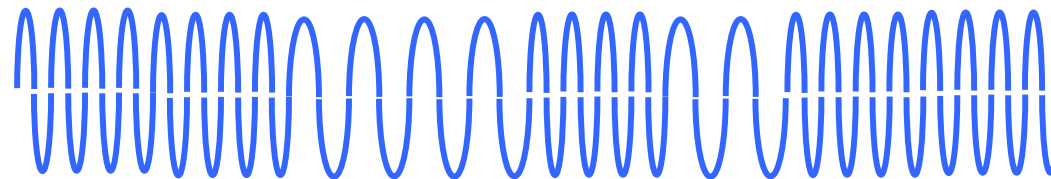

Frequency Shift Keying

BPSK (Binary Phase Shift Keying)

Phase shift keying is a digital modulation scheme that conveys data by changing, or modulating, the phase of the carrier wave. BPSK uses two phases which are separated by a half cycle.

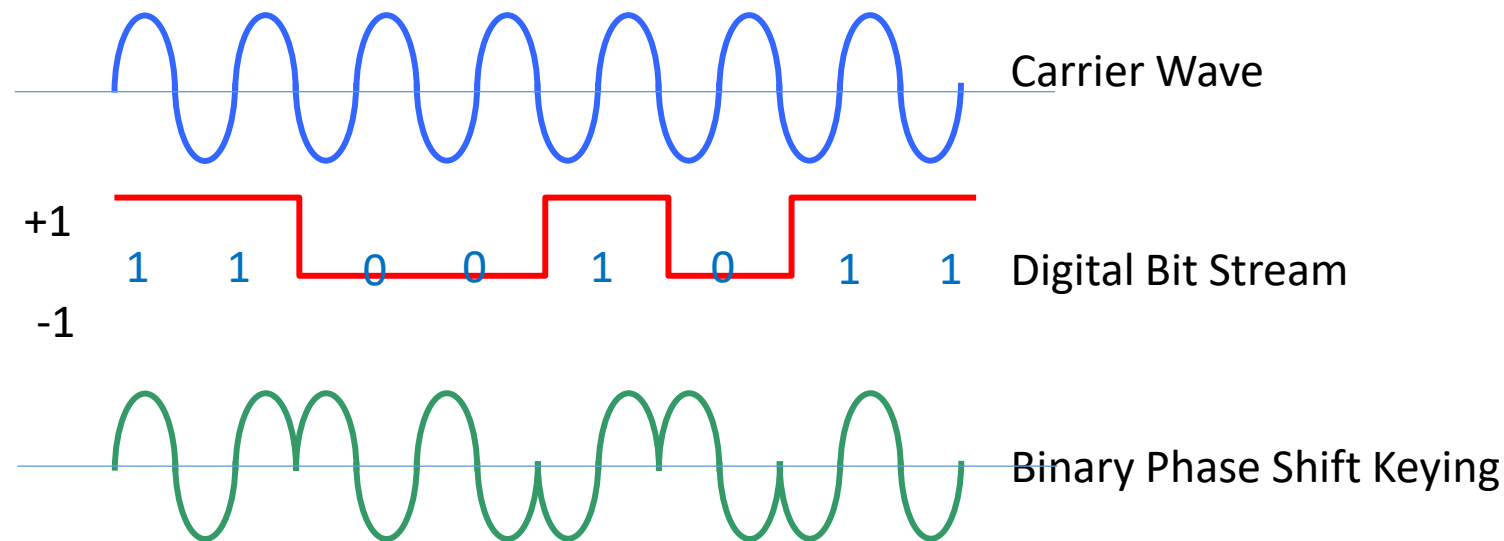

CDMA vs. FDMA

	CDMA [GPS, QZSS, Galileo, BeiDou, IRNSS, Future GLONASS Satellites]	FDMA [GLONASS]
PRN Code	Different PRN Code for each satellite Satellites are identified by PRN Code	One PRN Code for all satellites Satellites are identified by center frequency
Frequency	One Frequency for all satellites	Different frequency for each satellite
Merits & Demerits	Receiver design is simpler No Inter-Channel Bias More susceptible to Jamming	Receiver design is complex Inter-channel bias problem Less susceptible to Jamming

Navigation Data

- Navigation Data or Message is a continuous stream of digital data transmitted at 50 bit per second. Each satellite broadcasts the following information to users.
 - Its own highly accurate orbit and clock correction (**ephemeris**)
 - Approximate orbital correction for all other satellites (**almanac**)
 - System health, etc.

GPS L1C/A Signal NAV MSG

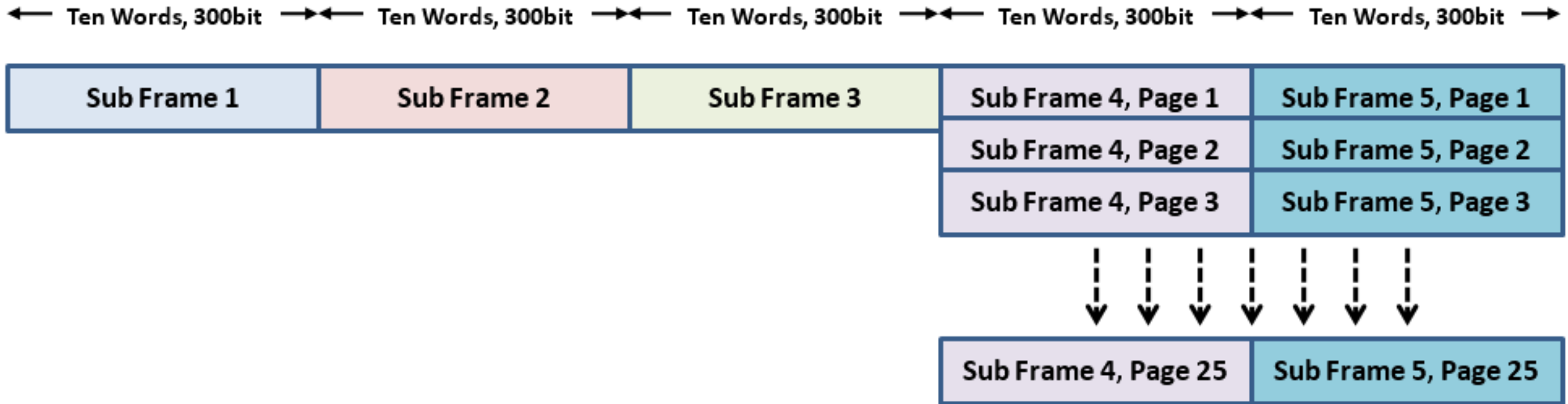

Principle of Satellite-based Navigation

(x^k, y^k, z^k)

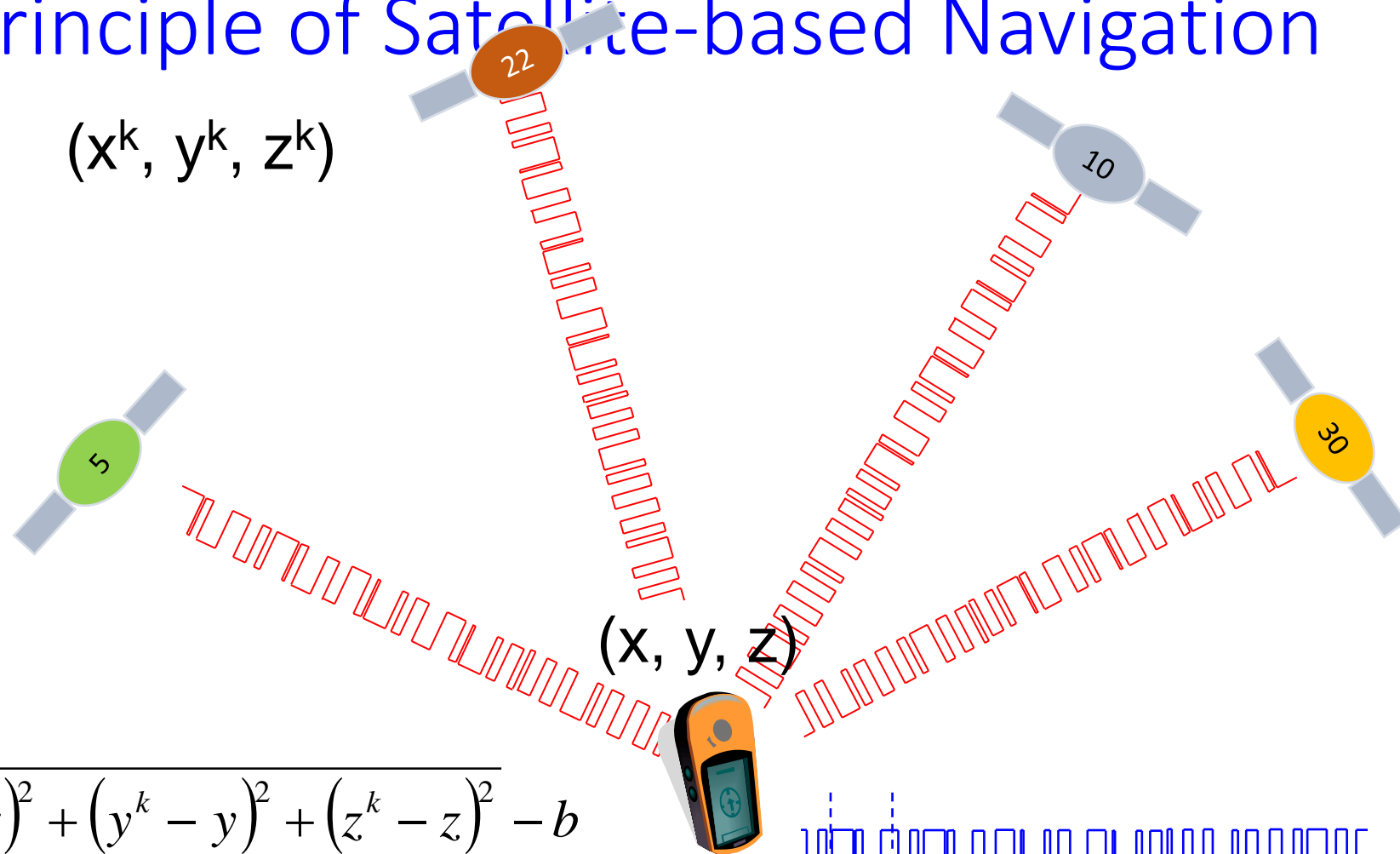

$$\rho^k = \sqrt{(x^k - x)^2 + (y^k - y)^2 + (z^k - z)^2} - b$$

If $k \geq 4$, solve for x, y, z and clock bias, b

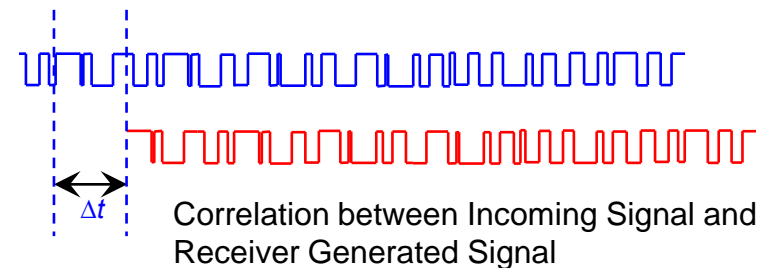

Pseudorange (1/2)

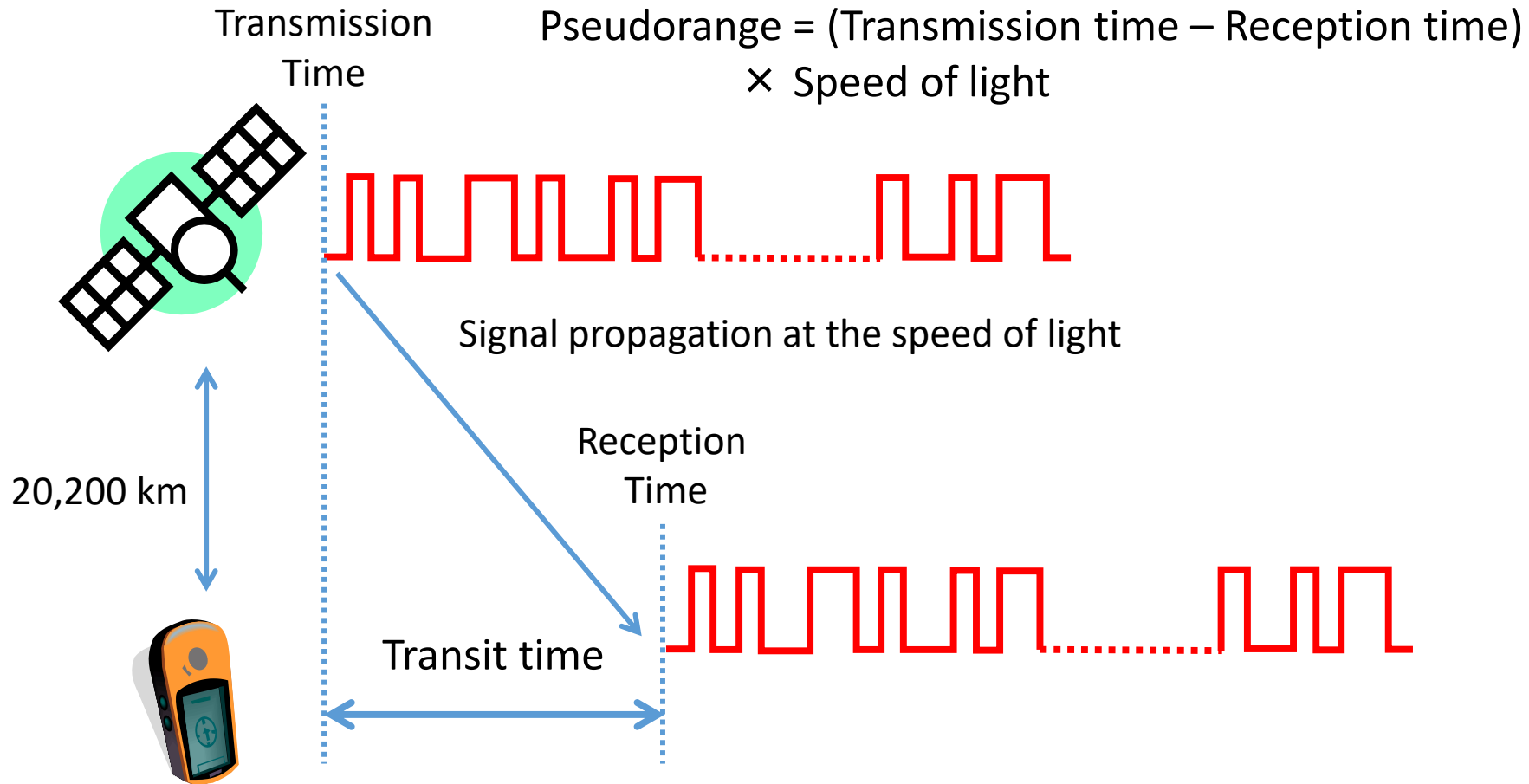

A GPS receiver measures the signal transmission time from the code phase at signal reception time.

Pseudorange (2/2)

- Essential GNSS observable
- **Full** distance between the satellite and the receiver
- Provides a position accuracy of approximately a few meters

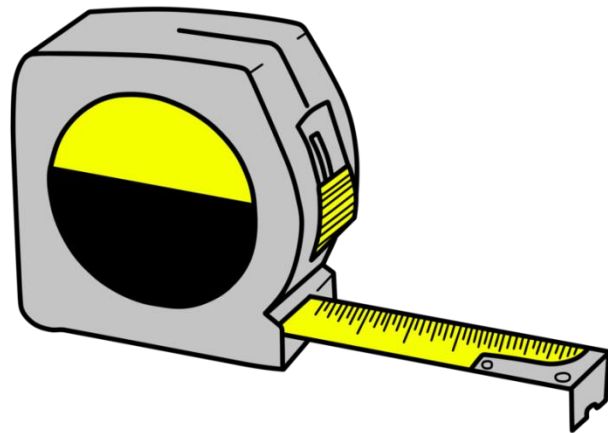

20,200 km

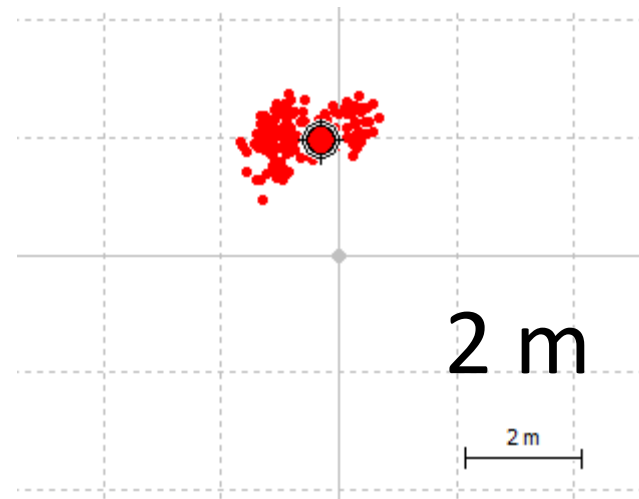

Carrier phase (1/2)

- PRN repeats every 1ms, which corresponds 300 km in distance at the speed of light, but pseudorange accuracy is about 1 m.
- Carrier phase provides millimeter range accuracy, but repeats every cycle, which correspond 19 cm in distance at a GPS signal carrier frequency of 1575.42 MHz.

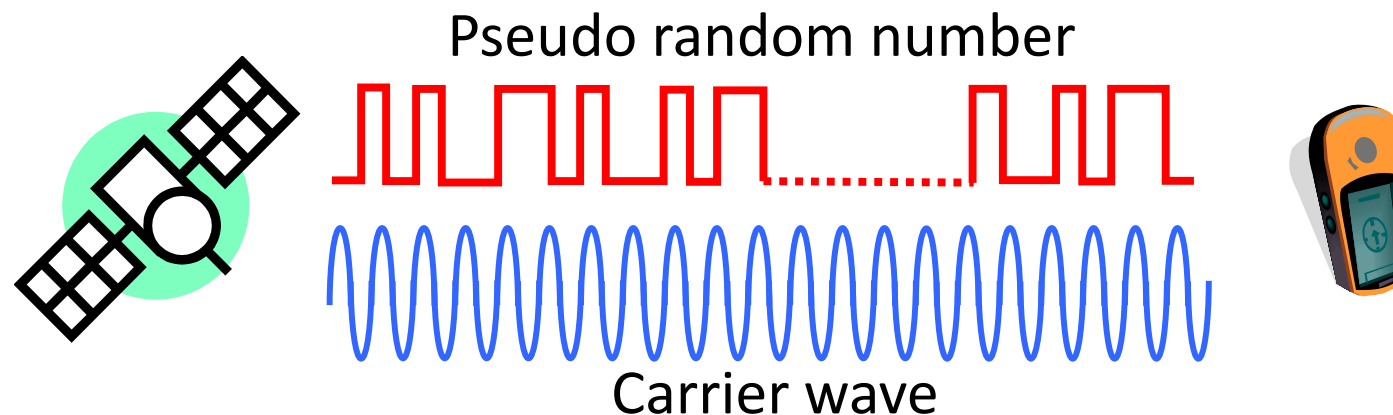

Carrier phase (2/2)

- **Fractional** carrier phase of the received signal
- Therefore there is an unknown integer number of full carrier cycles between the satellite and the receiver
- Provide “survey-grade” accuracy of 1-2 cm once the unknown number of full carrier cycles are resolved



19 cm

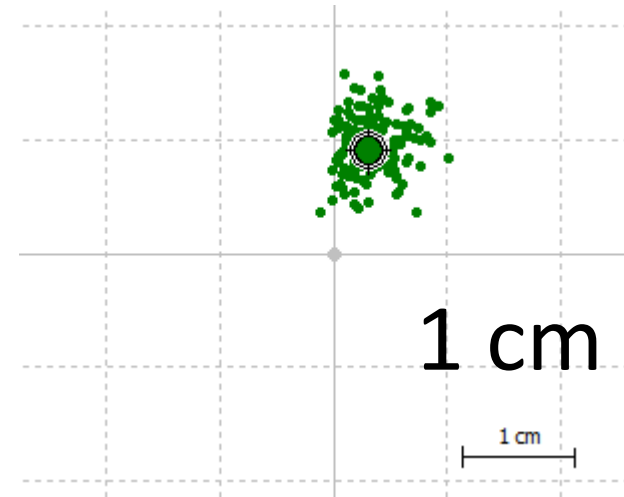

1 cm

1 cm

GNSS Architecture

Space Segment
GNSS Satellites

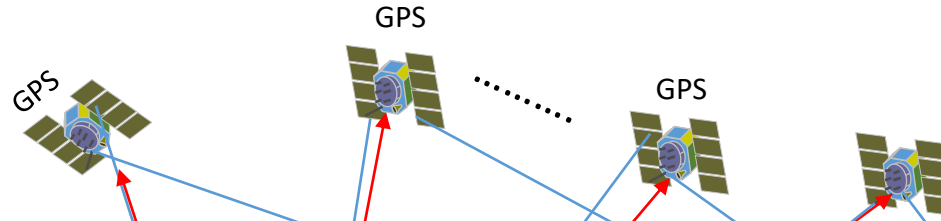

Control Segment

Monitor Satellite Health, Orbit, Clock etc
Upload Navigation Data to Satellites

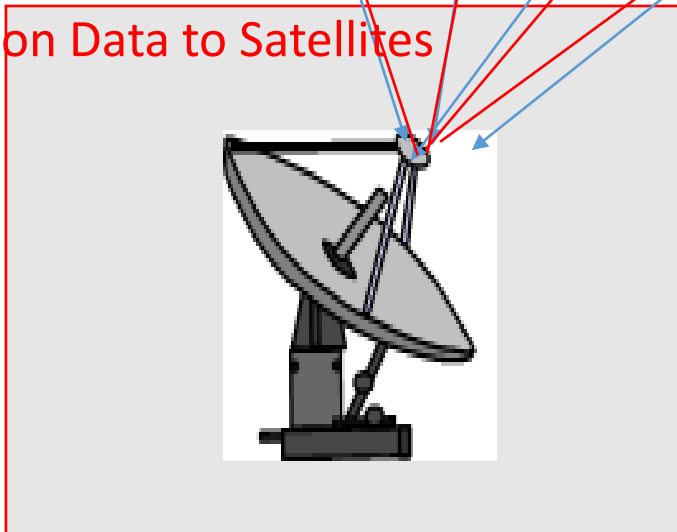

User Segment

GNSS Receivers
Applications that use GNSS



GPS Signal Power: How Strong or How Weak?

- GPS satellites are about 22,000km away
- Transmit power is about 30W
- This power when received at the receiver is reduced by 10^{16} times.
 - The power reduces by $1/\text{distance}^2$
 - This is similar to seeing a 30W bulb 22,000Km far
- GPS signals in the receiver is about 10^{-16} Watt, which is below the thermal noise

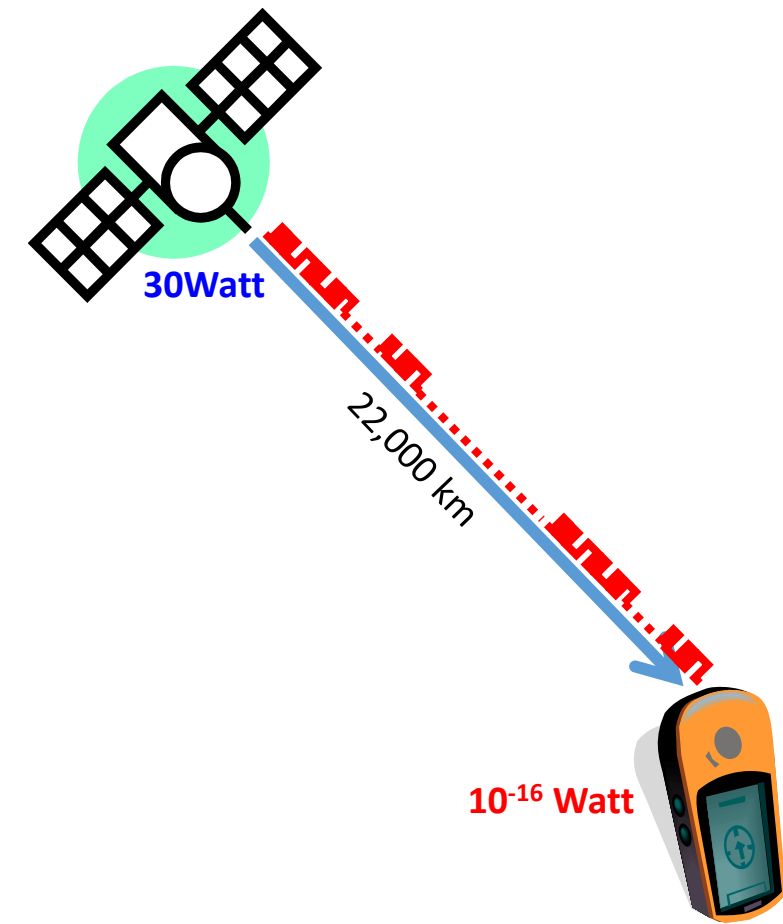

GPS Signal Power: How Strong or How Weak?

- GPS Signal Power at Receiver
 - -130dBm or -160dBW
- Thermal Noise Power
 - Defined by $kT_{eff}B$, where
 - $K = 1.380658e-23JK^{-1}$, Boltzman Constant
 - $T_{eff} = 362.95$, for Room temperature in Kelvin at 290
 - Teff is effective Temperature based on Frii's formula
 - $B = 2.046MHz$, Signal bandwidth
 - Thermal Noise Power = -110dBm for 2MHz bandwidth
 - If Bandwidth is narrow, 50Hz
 - Noise Power = -156dBm

GPS Signal Power

Noise Power
Any Signal below this
noise level can't be
measured in a
Spectrum Analyzer

GPS Signal Power at
Antenna, -130dBm

Mobile phone, WiFi,
BT etc have power
level above -110dBm,
much higher than GPS
Signal Power

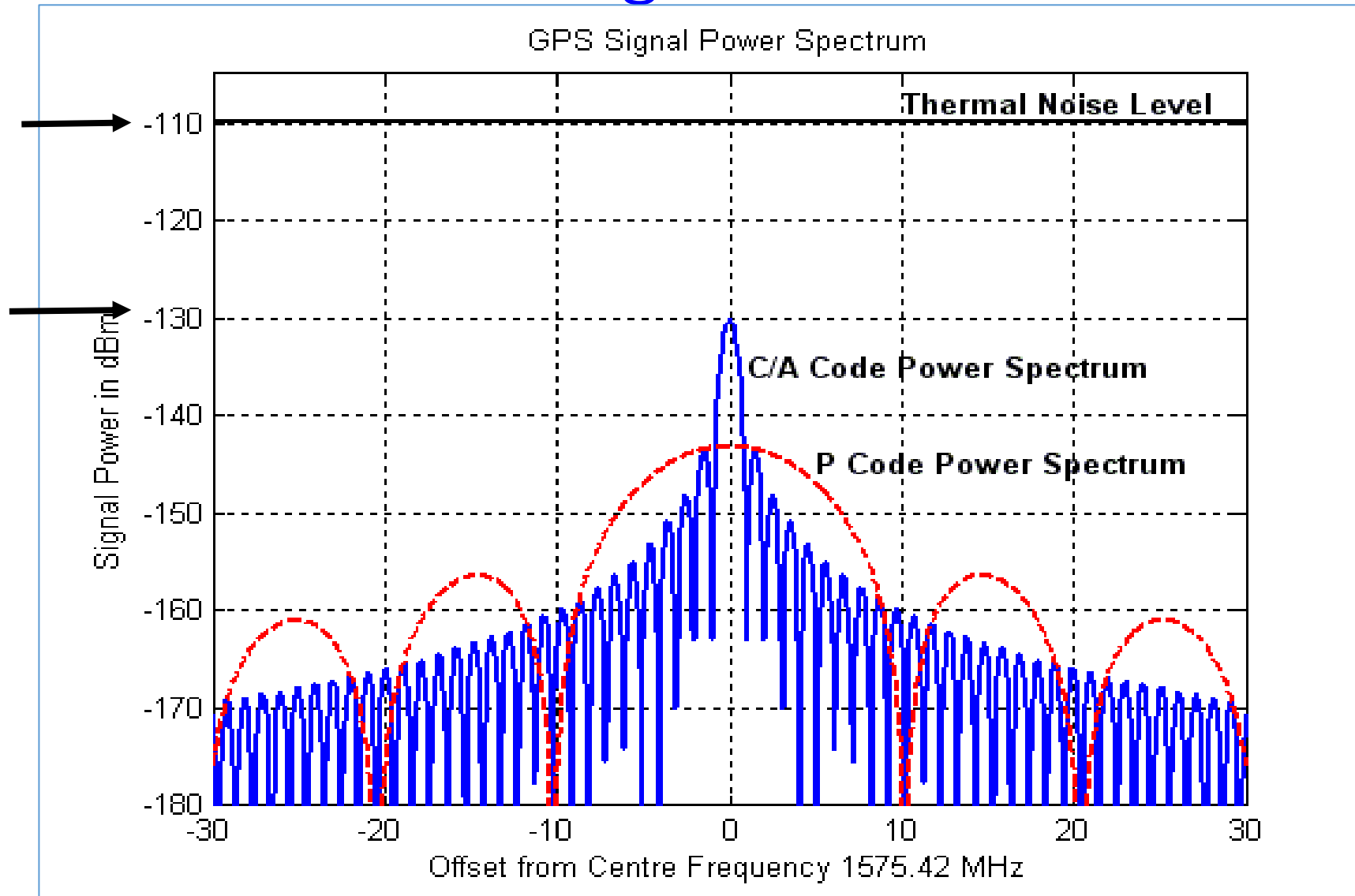

Power of GPS Signal vs. Other Signals

	Signal Type	Power (based on calculations, not measured)		
		Watt	dBW	dBm
Above Noise	Mobile Phone Handset TX Power *	1W	0dBW	30dBm
	RX Power at Mobile Phone Handset*	100e-6W	-40dBW	-70dBm
	ZigBee	316e-16W	-115dBW	-85dBm
	VHF	200e-16W	-137dBW	-107dBm
Below Noise	Thermal Noise	79e-16W	-141dBW	-111dBm
	GPS**	1e-16W	-160dBW	-130dBm

- * Actual power values will differ. These are just for comparison purpose
- ** GPS Signals are hidden under the noise. Thus, it can't be measured directly e.g. using a Spectrum Analyzer

GPS, USA (Global Positioning System)

History of GPS (1/2)

- Originally designed for military applications at the height of the Cold War in the 1960s, with inspiration coming from the launch of the Soviet spacecraft Sputnik in 1957.
- Transit was the first satellite system launched by the United States and tested by the US Navy in 1960.
 - Just five satellites orbiting the earth allowed ships to fix their position on the seas once every hour.
- GPS developed quickly for military purposes thereafter with a total of 11 “Block” satellites being launched between 1978 and 1985.
- The Reagan Administration in the US had the incentive to open up GPS for civilian applications in 1983.

How to Drop Five Bombs from Different Aircrafts into the Same Hole?

(with an accuracy of 10m)

History of GPS (2/2)

- Upgrading the GPS was delayed by NASA space shuttle Challenger disaster in 1989 and it was not until 1990 that the first Block II satellites were launched.
- By the summer of 1993, the US launched the 24th GPS satellite into orbit, which completed the modern GPS constellation of satellites.
- In 1995, it was declared fully operational.
- Today's GPS constellation has **31** active satellites.
- GPS is used for applications that require **position and time data**.

GPS Space Segment: Current & Future Constellation

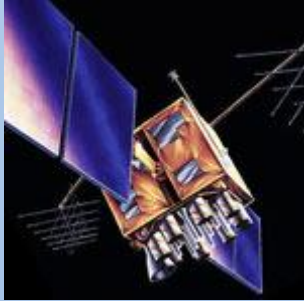
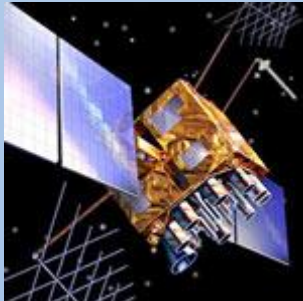
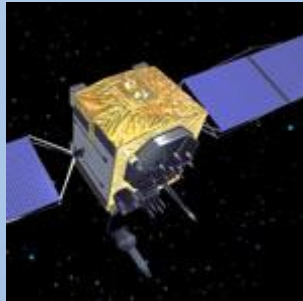
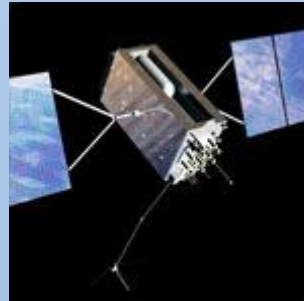
Legacy Satellites		Modernized Satellites		
				
Block IIA	Block IIR	Block IIR(M)	Block IIF	GPS III
0 operational	12 operational	7 operational	12 operational	In production
<ul style="list-style-type: none"> •L1C/A, L1 P(Y) •L2P(Y) •Launched in 1990-1997 •Last one decommissioned in 2016 	<ul style="list-style-type: none"> •L1C/A, L1P(Y) •L2P(Y) •Launched in 1997-2004 	<ul style="list-style-type: none"> •L1C/A, L1P(Y) •L2P(Y) •L2C, L2M •Launched in 2005-2009 	<ul style="list-style-type: none"> •L1C/A, L1P(Y) •L2P(Y) •L2C, L2M •L5 •Launched in 2010-2016 	<ul style="list-style-type: none"> •L1C/A, L1P(Y) •L2P(Y) •L2C, L2M •L5 •L1C •Available for launch in 2016

See File 02_GPS_ICG_2019.pdf
for latest information as per DEC 2019

<http://www.gps.gov/systems/gps/space/#IIF>
https://en.wikipedia.org/wiki/Global_Positioning_System

Information (number of satellites) in this slide are not updated
Please check the following site for the latest updates:

<https://www.unoosa.org/oosa/en/ourwork/icg/annual-meetings.html>

GPS Signals

Band	Frequency, MHz	Signal Type	Code Length msec	Chip Rate, MHz	Modulation Type	Data / Symbol Rate, bps/sps	Notes
L1	1575.42	C/A	1	1.023	BPSK	50	Legacy Signal
		C _{Data}	10	1.023	BOC(1,1)	50 / 100	From 2014
		C _{Pilot}	10	1.023	TMBOC	No Data	BOC(1,1) & BOC(6,1)
		P(Y)	7 days	10.23	BPSK		Restricted
L2	1227.60	CM	20	0.5115	BPSK	25 / 50	Modulated by TDM of (L2CM xor Data) and L2CL
		CL	1500	0.5115		No Data	
		P(Y)	7days	10.23	BPSK		
L5	1176.45	I	1	10.23	BPSK	50 / 100	Provides Higher Accuracy
		Q	1			No Data	

GPS Receiver Outputs (1/3)

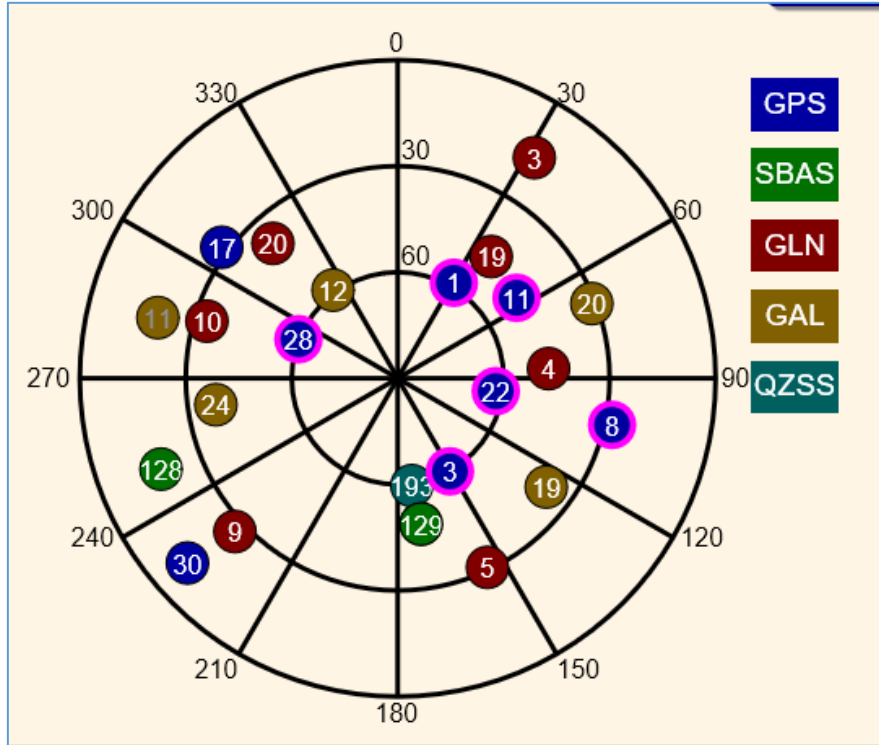

Sky Plot: Visibility of Satellites at Receiver Antenna

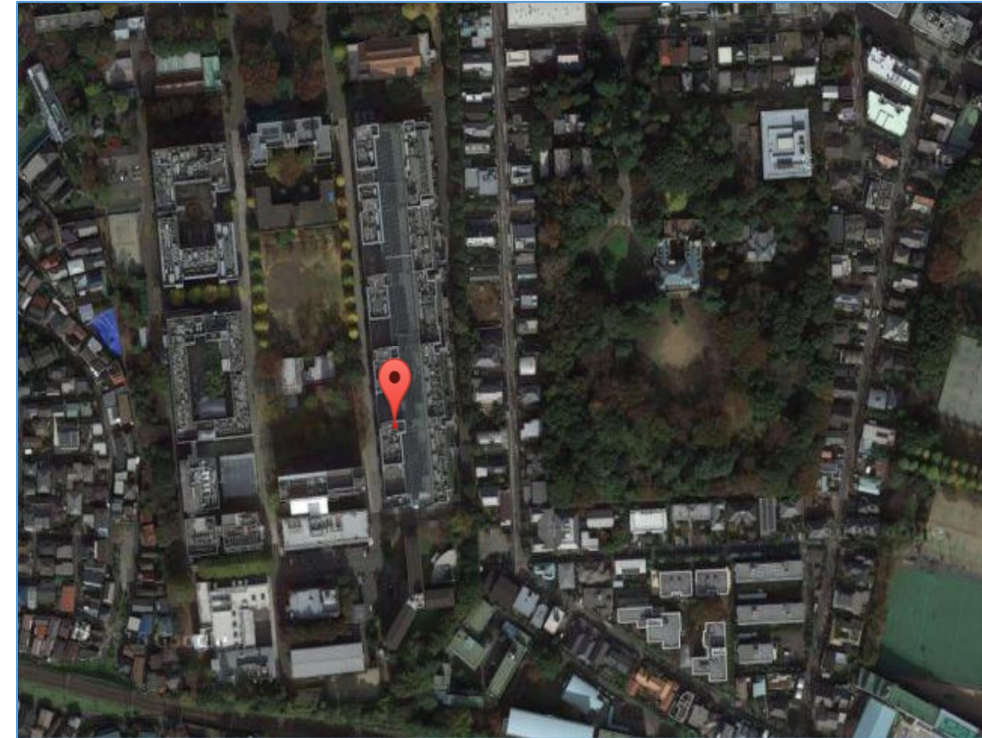

Computed Position from GPS displayed over Google Map

GPS Receiver Outputs (2/3)

GNSS Signals Received by the Receiver

ALL	GPS	GLONASS		Galileo	QZSS	SBAS	OMNI								
SV	Type	Elev. [Deg]	Azim. [Deg]	L1-C/No [dBHz]	L1	L2-C/No [dBHz]	L2	L5-C/No [dBHz]	L5	E6-C/No [dBHz]	E6	IODE	URA [m]	Type	
1	GPS	57.51	31.89	42.7	CA	26.4/42.8	E/CM+CL	-	-	-	-	17	2	IIF	
3	GPS	61.11	148.93	43.4	CA	27.4/43.9	E/CM+CL	-	-	-	-	17	2	IIF	
8	GPS	26.97	103.42	37.3	CA	16.9/36.6	E/CM+CL	-	-	-	-	59	2	IIF	
11	GPS	48.36	57.30	41.4	CA	22.3	E	-	-	-	-	83	4	IIR	
17	GPS	28.92	307.48	37.9	CA	19.3/37.5	E/CM+CL	-	-	-	-	41	2	IIR-M	
22	GPS	61.99	94.37	43.9	CA	26.8	E	-	-	-	-	49	2	IIR	
28	GPS	60.44	288.95	43.0	CA	25.3	E	-	-	-	-	53	2.8	IIR	
11	Galileo	20.59	285.13	-	-	-	-	-	-	-	-	-	-	-	
12	Galileo	59.51	325.63	41.5	CBOC	-	-	-/40.6/40.2	-/B/Alt	-	-	-	-	-	
19	Galileo	38.81	125.12	37.7	CBOC	-	-	-/33.8/33.3	-/B/Alt	-	-	-	-	-	
20	Galileo	31.05	67.70	33.9	CBOC	-	-	-	-	-	-	-	-	-	
24	Galileo	37.41	260.41	40.9	CBOC	-	-	-/40.2/39.9	-/B/Alt	-	-	-	-	-	
3	GLONASS	15.60	30.81	33.7/32.3	CA/P	32.3	CA	-	-	-	-	29	2.5	M	
4	GLONASS	47.52	83.80	40.5/39.4	CA/P	38.1	CA	-	-	-	-	29	7	M	
5	GLONASS	32.37	153.94	32.3/31.0	CA/P	31.0	CA	-	-	-	-	29	2.5	M	
9	GLONASS	25.40	225.73	35.6/34.4	CA/P	36.4	CA	-	-	-	-	29	10	M	
10	GLONASS	33.33	284.69	39.0/37.6	CA/P	30.9	CA	-	-	-	-	29	4	M	
19	GLONASS	46.12	39.85	37.1/35.9	CA/P	36.9	CA	-	-	-	-	29	4	M	
20	GLONASS	38.75	318.99	33.0/30.7	CA/P	37.4	CA	-	-	-	-	29	10	M	
193	QZSS	59.95	172.80	40.9/42.0/40.7	CA/BOC/SAIF	40.4	CM+CL	-	-	29.2	LEX	212	2	-	
128	SBAS	18.24	249.03	32.4	CA	-	-	-	-	-	-	158	4096	-	
129	SBAS	48.27	170.87	34.3	CA	-	-	-	-	-	-	124	4096	-	
137	SBAS	48.27	170.87	34.1	CA	-	-	-	-	-	-	46	16	-	
140	SBAS	-45.00	0.00	35.5	CA	-	-	-	-	-	-	55	N/A	-	
141	SBAS	-45.00	0.00	-	-	-	-	-	-	-	-	-	-	-	





GPS Receiver Outputs (3/3)

Position, Velocity, Time (PVT) and Other Observation Related Outputs

<p>Position: Lat: 35° 39' 40.85496" N Lon: 139° 40' 41.32632" E Hgt: 118.521 [m] Type: Autonomous Datum: WGS-84</p>	<p>Satellites Used:19 GPS(7): 1, 3, 8, 11, 17, 22, 28 GLONASS(8): 3, 4, 5, 9, 10, 11, 19, 20 Galileo(3): 12, 19, 24 QZSS(1): 193</p>	<p>Dilutions of Precision: PDOP: 1.5 HDOP: 0.7 VDOP: 1.3 TDOP: 1.1</p>
<p>Velocity: East: 0.01 [m/s] North: -0.01 [m/s] Up: -0.02 [m/s]</p>	<p>Satellites Tracked:23 GPS (7): 1, 3, 8, 11, 17, 22, 28 GLONASS (8): 3, 4, 5, 9, 10, 11, 19, 20 Galileo (4): 12, 19, 20, 24 SBAS (3): 128, 137, 140 QZSS (1): 193</p>	<p>Error Estimates(1σ): East: 0.878 [m] North: 1.123 [m] Up: 2.691 [m] Semi Major Axis: 1.155 [m] Semi Minor Axis: 0.834 [m] Orientation: 19.9°</p>
<p>Position Solution Detail: Position Dimension: 3D Augmentation: GPS+GLN+GAL+QZSS Height Mode: Normal Correction Controls: Off</p>	<p>Receiver Clock: GPS Week: 1910 GPS Seconds: 447816 Offset: 0.00001 [msec] Drift: 0.00007 [ppm]</p>	
	<p>Multi-System Clock Offsets: Master Clock System: GPS GLONASS Offset: 97.2 [ns] Galileo Offset: 0.5 [ns] GLONASS Drift: -0.044 [ns/s] Galileo Drift: 0.003 [ns/s]</p>	

GLONASS, Russia (Global Navigation Satellite System)

GLONASS Current & Future Constellation

1982 First Launch	2003	2011	Planned Launch
			
GLONASS	GLONASS-M	GLONASS-K1	GLONASS-K2
DECOMMISSIONED 87 Launched 0 Operational 81 Retired 6 Lost	Under Normal Operation 45 Launched 27 Operational 12 Retired 6 Lost	Under Production / Operation 2 Launched 2 Operational First launch Dec 2014	Under Development 3 On Order First Launch Expected 2018
<p>See File 03-GLONASS_ICG_2019.pdf for latest information as per DEC 2019</p> <ul style="list-style-type: none"> •L1OF, L1SF • L2SF 	<ul style="list-style-type: none"> •L1OF, L1SF •L2OF, L2SF •L3OC 	<ul style="list-style-type: none"> •L1OF, L1SF •L2OF, L2SF •L3OC 	<ul style="list-style-type: none"> •L1OF, L1SF •L2OF, L2SF •L1OC, L1SC •L2OC, L2SC •L3OC

Information (Number of Satellites) in this slide are not updated
Please check the following site for the latest updates:
<https://www.unoosa.org/oosa/en/ourwork/icg/annual-meetings.html>

GLONASS space segment STATUS & MODERNIZATION, Joint - Stock Company «Academician M.F. Reshetnev» Information Satellite Systems»
ICG-7, November 04-09, 2012, Beijing, China, <https://en.wikipedia.org/wiki/GLONASS-K2>

GLONASS FDMA Signals

- L1 Band 1598.0625 - 1604.40 MHz
 - $1602 \text{ MHz} + n \times 0.5625 \text{ MHz}$
 - where n is a satellite's frequency channel number ($n=-7,-6,-5,\dots,7$).
- L2 Band 1242.9375 - 1248.63 MHz
 - $1246 \text{ MHz} + n \times 0.4375 \text{ MHz}$

Galileo, Europe

Galileo Space Segment

Galileo is implemented in a step-wise approach

By 2020 Galileo will be:

- ★ fully deployed and recognised
- ★ adopted by the widest user communities
- ★ a civilian infrastructure delivering robust positioning and timing services with high degree of performances

Full Operational Capability
Full services, 30 satellites
2020

Initial Services Provision
Initial services for OS, SAR, PRS, and demonstrator for CS
2016

In-Orbit Validation
4 operational satellites and ground segment
2013

GIOVE A/B
2 test satellites
2005/2008

Galileo System Testbed v1
Validation of critical algorithms
2003



See file 04-GALILEO_ICG_2019.pdf for latest information as per DEC 2019

Information (number of satellites) in this slide are not updated
Please check the following site for the latest updates:
<https://www.unoosa.org/oosa/en/ourwork/icg/annual-meetings.html>

GSTB-V1



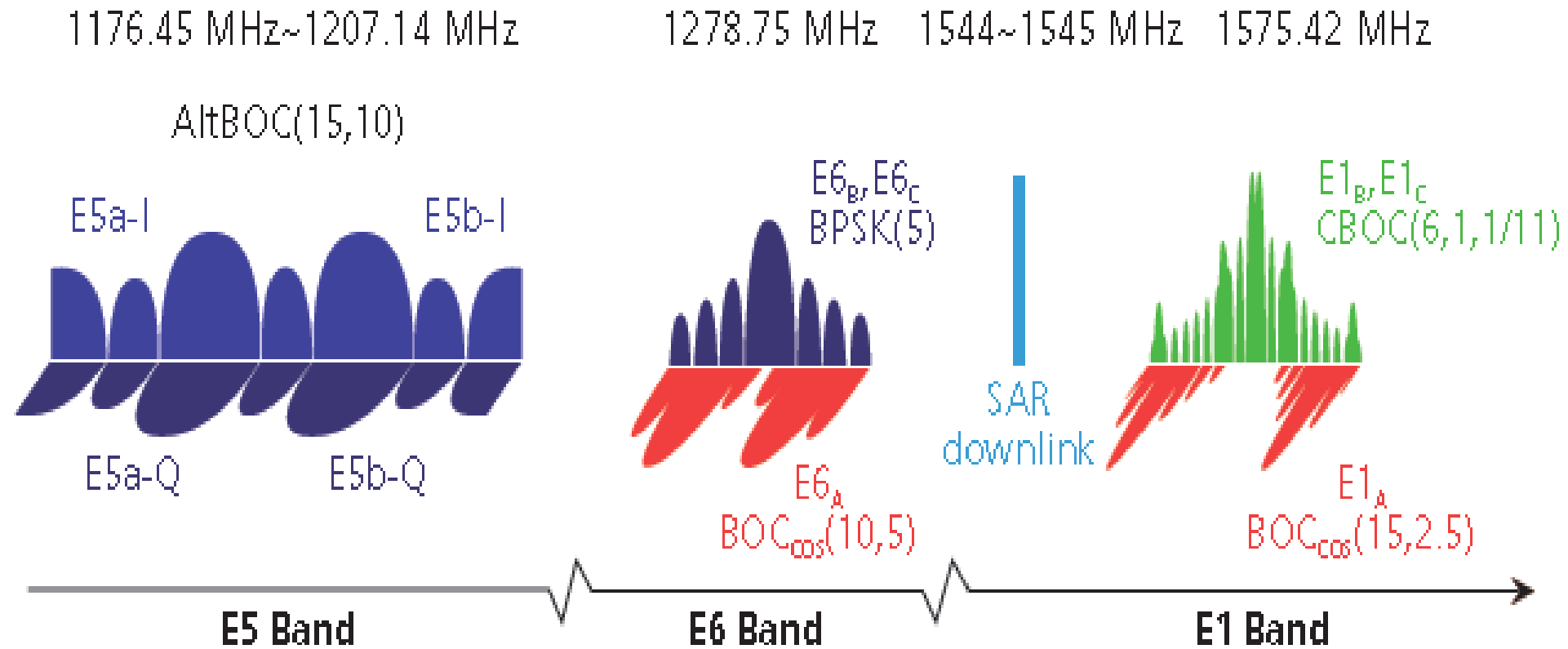

Galileo Signals

Band	Frequency, MHz	Signal Type	Code Length msec	Chip Rate, MHz	Modulation Type	Data / Symbol Rate, bps/sps	Notes
E1	1575.42	A	10	10.23	BOC(15,2.5)	??	Restricted
		B _{Data}	4	1.023	CBOC, Weighted combination of BOC(1,1) & BOC(6,1)	125 / 250	Data
		C _{Pilot}	100	1.023		No Data	Pilot
E6	1278.75	A	10	5.115	BOC(15,5)	??	PRS
		B	1	5.115	BPSK(5)	500 / 1000	Data
		C	100	5.115		No Data	Pilot
E5 1191.795 MHz	1176.45	A-I	20	10.23	AltBOC(15,10)	25 / 50	Data
		A-Q	100	10.23		No Data	Pilot
	1207.14	B-I	4	10.23		125 / 250	Data
		B-Q	100	10.23		No Data	Pilot

Galileo Signals

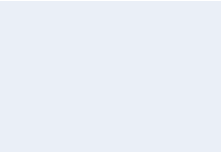

Galileo Services

<p>Open Service (OS)</p>	<p>Freely accessible service for positioning, navigation and timing for mass market</p>	
<p>Commercial Service (CS)</p>	<p>Delivers authentication, high accuracy and guaranteed services for commercial applications</p>	
<p>Public Regulated Service (PRS)</p>	<p>Encrypted service designed for greater robustness in challenging environments</p>	
<p>Search And Rescue Service (SAR)</p>	<p>Locates distress beacons and confirms that message is received</p>	
<p>Safety of Life Service (SoL)</p>	<p>The former Safety of Life service is being re-profiled</p>	

BeiDou / BDS, China

BeiDou Space Segment

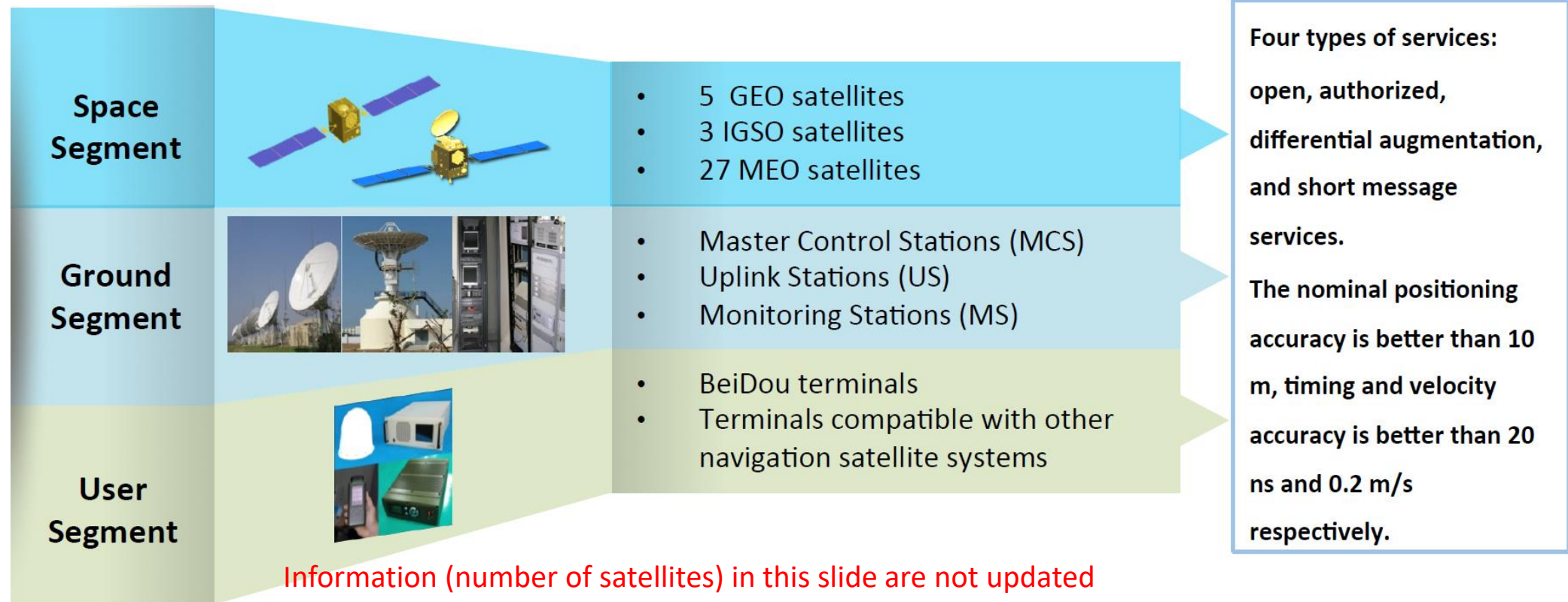

Information (number of satellites) in this slide are not updated
Please check the following site for the latest updates:

<https://www.unoosa.org/oosa/en/ourwork/icg/annual-meetings.html>

Source: Update on BeiDou Navigation Satellite System, Chengqi Ran, China Satellite Navigation Office
Tenth Meeting of ICG, NOV 2015

COMPASS / BEIDOU Signals: Already Transmitted

Band	Frequency MHz	Signal Type	Chip Rate (MHz)	Modulation Type	Data / Symbol rate	Notes
B1	1561.098	B1(I)	2.046	QPSK	50 / 100	Open
		B1(Q)			None	Authorized
	1589.742	B1-2(I)	2.046	QPSK	50 / 100	Open
		B1-2(Q)			25 / 50	Authorized
B2	1207.14	B2(I)	2.046	QPSK	None	Open
		B2(Q)	10.23		50 / 100	Authorized
B3	1268.52	B3	10.23	QPSK	500	Authorized

Development of BDS

- 5th NOV 2017
 - The first Two BDS – 3 MEO satellites were successfully launched.
- The BDS-3 satellites are equipped with two new civil signals, B1C and B2a, with optimized performance.
- The Interface Control Document for B1C and B2a (Beta version) has been released, and the official version will be released in 2018.

BDS-3 Constellation

- Since 5th NOV 2017, 8 pairs of BDS-3 MEO satellites and 1 BDS GEO satellite have been successfully launched.

Satellite	Launch Time
First pair	2017.11.05
Second pair	2018.01.12
Third pair	2018.02.11
Fourth pair	2018.03.30
Fifth pair	2018.07.29
Sixth pair	2018.08.25
Seventh pair	2018.09.19
Eighth pair	2018.10.15
First GEO	2018.11.01

See File 05-BEIDOU_ICG_2019.pdf
for the latest information as per DEC 2019

Source: Plenary Session of ICG 2018

BDS-3 Services

Service Type	Satellites
RNSS	3 GEO + 3 IGSO + 24 MEO
SBAS	3 GEO
Regional SMS	3 GEO
Global SMS	14 MEO
International SAR	6 MEO
PPP (Precise Point Positioning)	3 GEO

Source: Plenary Session of ICG 2018

QZSS / Michibiki, Japan (Quasi-Zenith Satellite System)

Merits of QZSS

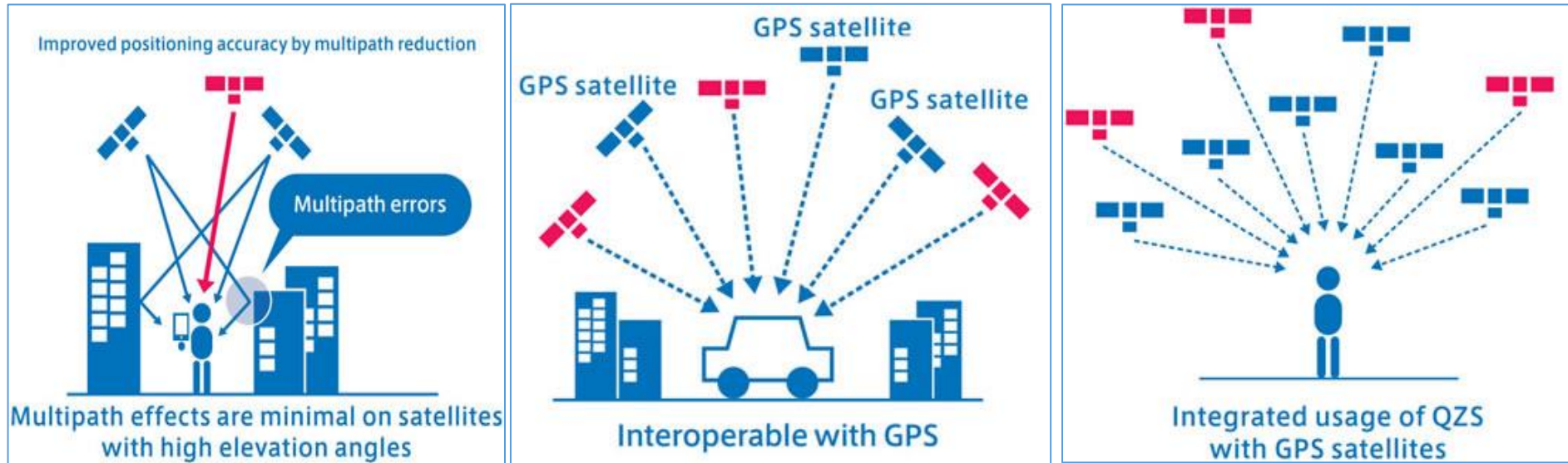

- QZSS signal is designed in such a way that it is **interoperable with GPS**
- QZSS is visible near zenith; improves visibility & DOP in dense urban area
- Provides Orbit Data of other GNSS signals
- Provides **Augmentation Data for Sub-meter and Centimeter level position accuracy**
- Provides Messaging System during Disasters

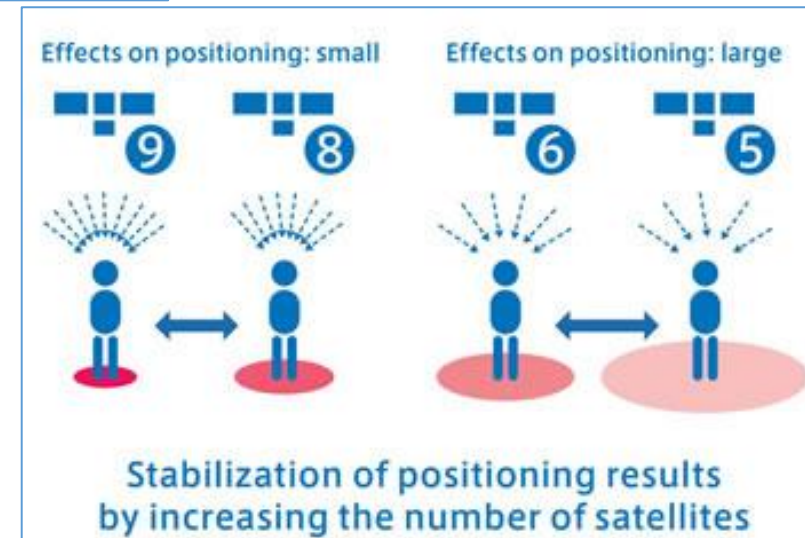

http://qzss.go.jp/en/overview/services/sv04_pnt.html

QZSS Development Plan

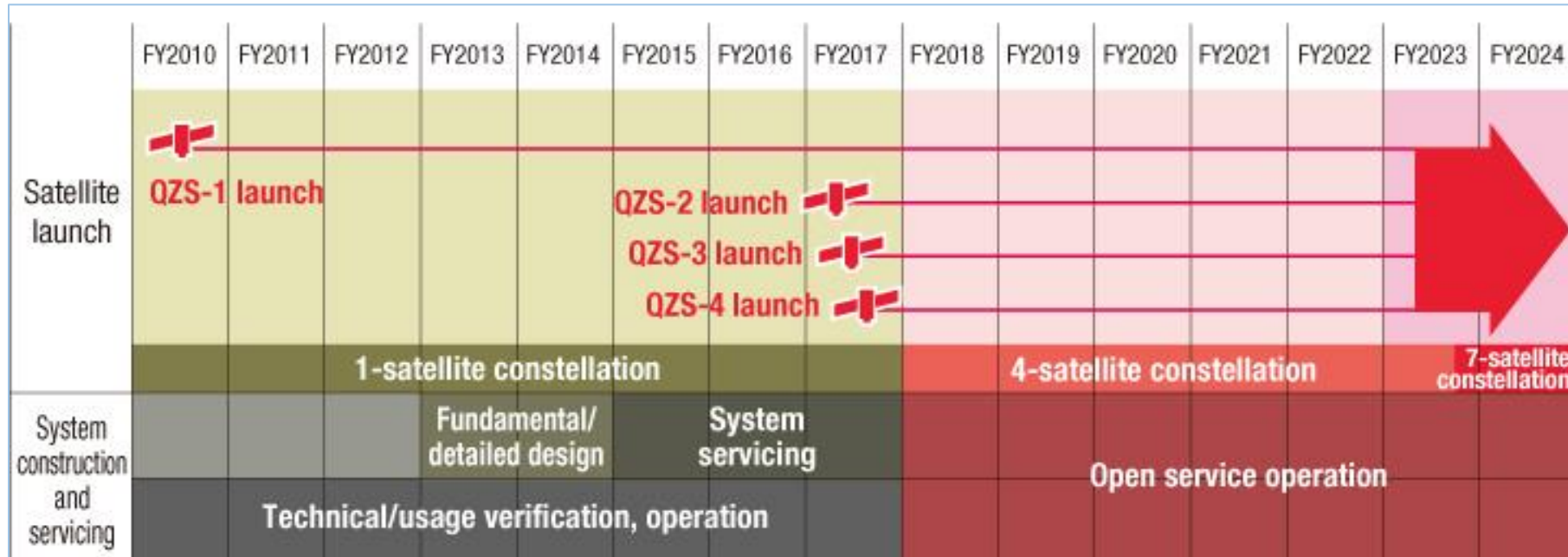

1st Satellite launched on 11th September 2010

: QZ Orbit

See file 06-QZSS_ICG_2019.pdf

2nd Satellite launched on 1st June 2017

: QZ Orbit

for the latest information as per DEC 2019

3rd Satellite launched on 19th August 2017

: Geostationary Orbit

Information (number of satellites) in this slide are not updated

Please check the following site for the latest updates:

<https://www.unoosa.org/oosa/en/ourwork/icg/annual-meetings.html>

QZSS Constellation Status

- Current Status
 - One Satellite launched on 11th SEP 2010
- Total constellation of Seven Satellites
 - Three more satellites were launched by the end of 2017

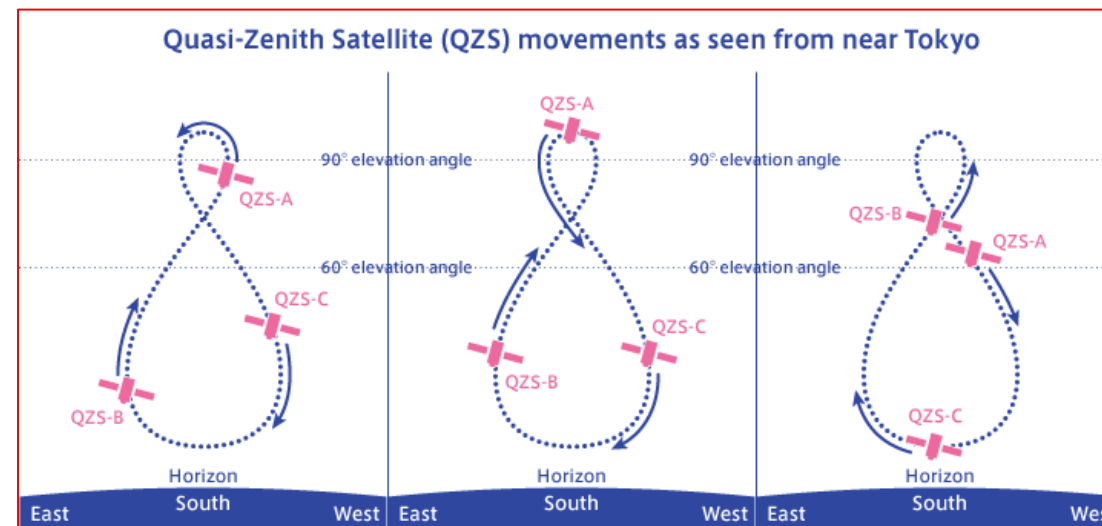

QZSS Satellites & Signal Types

Signal Name	QZS-1	QZS-2 to QZS-4		Transmission service	Center Frequency MHz
	Block IQ	Block IIQ	Block IIG		
	(QZO)	(QZO)	(GEO)		
	1	2	1		
L1C/A	◎	◎	◎	Satellite positioning service	1575.42
L1C	◎	◎	◎	Satellite positioning service	
L1SAIF	◎			Sub-meter Level Augmentation Service (SLAS) / Disaster and Crisis Management	
L1S		◎	◎		
L1Sb	-	-	◎	SBAS Transmission Service from around 2020	
L2C	◎	◎	◎	Satellite positioning service	1227.60
L5	◎	◎	◎	Satellite positioning service	1176.45
L5S	-	◎	◎	Positioning Technology Verification Service	
LEX	◎			MADOCA	1278.75
L6		◎	◎	Centimeter Level Augmentation Service (CLAS)	
S-band	-	-	◎	QZSS Safety Service / SAR	2GHz

QZSS Satellite Visibility

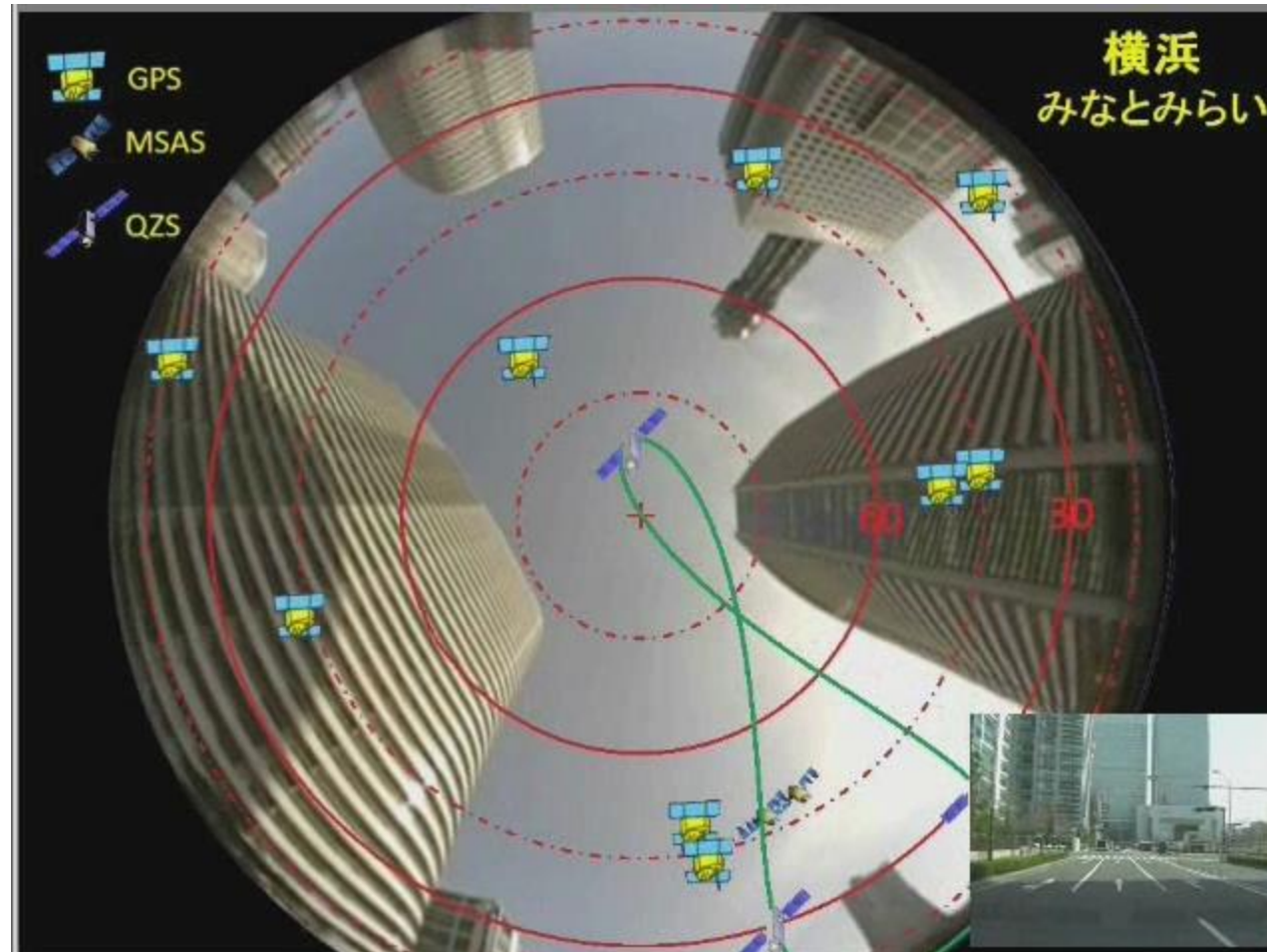

Source: SPAC Animation Video

QZSS New Applications

QZSS New Applications

- Short Message Broadcast during Emergencies and Disasters
 - L1SAIF → L1S Signals
- Sub-meter Level Augmentation Service (SLAS)
 - L1SAIF → L1S
 - L1Sb Signals
- Centimeter Level Augmentation Service (CLAS)
 - L6-D Signal
 - PPP-RTK
- Multi-GNSS Advanced Demonstration tool for Orbit and Clock Analysis (MADOCA)
 - L6-E Signal
 - PPP / PPP-AR

Short Message Broadcast during Disaster



Sub-meter Level Augmentation Service (SLAS)

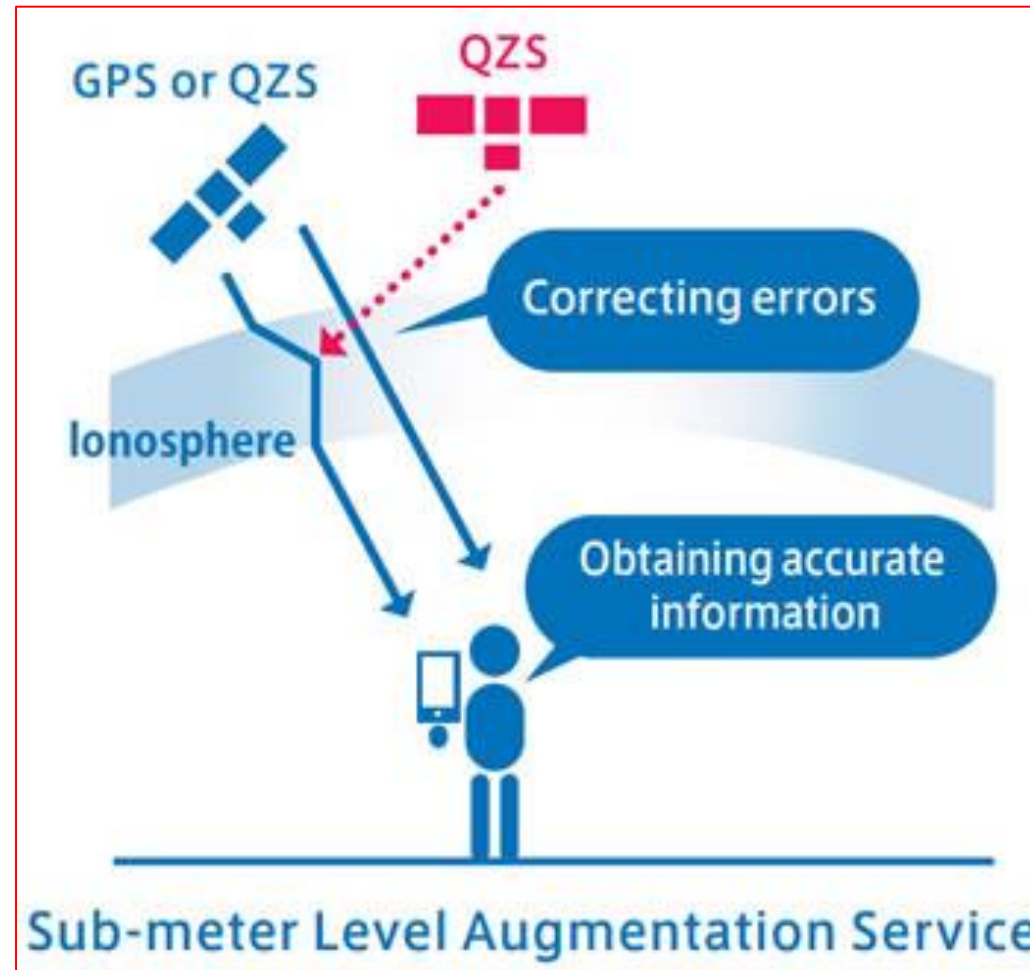

SLAS : Sub-meter Level Augmentation Service

Signal Used: L1SAIF / L1S

Centimeter Level Augmentation Service (CLAS)

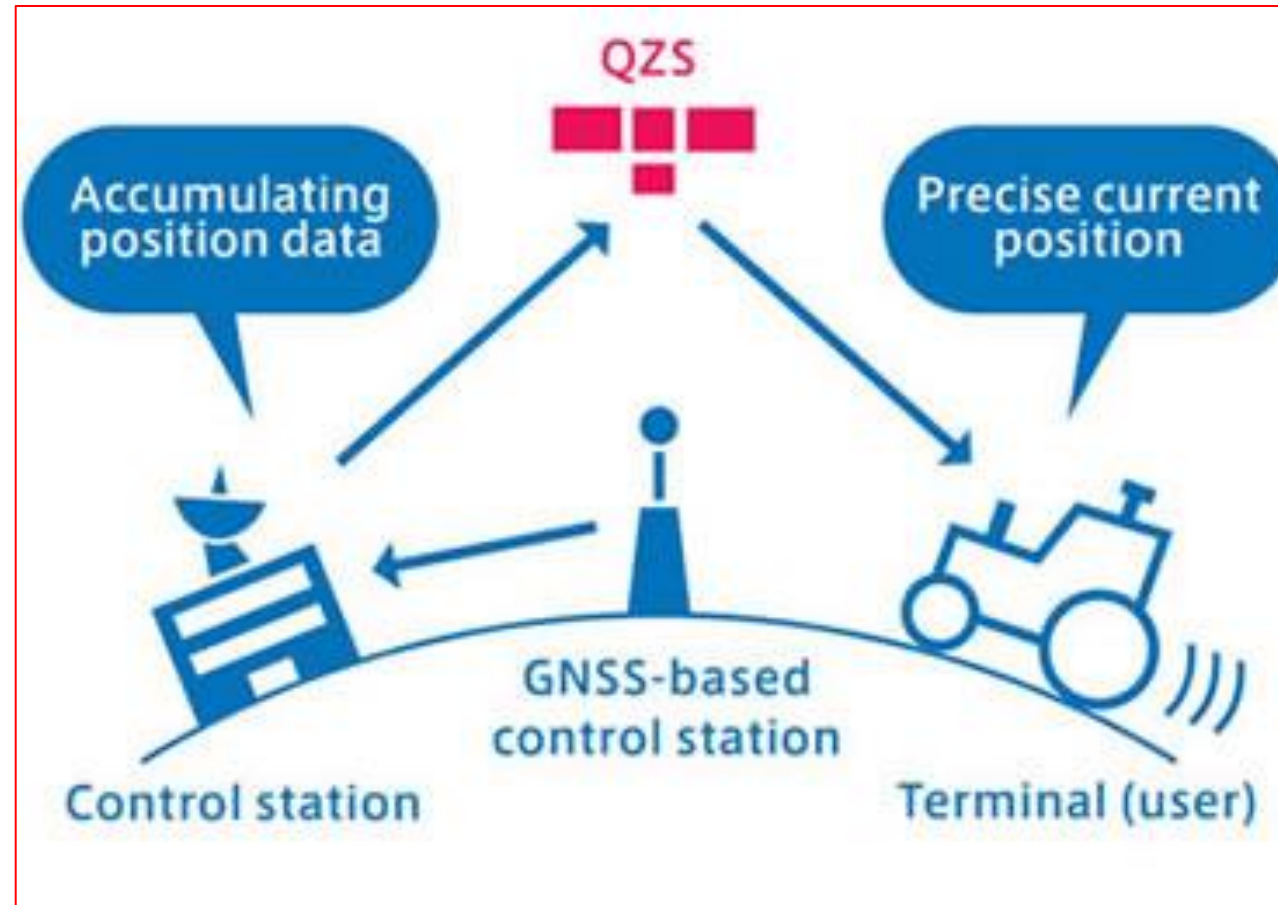

CLAS : Centimeter Level Augmentation Service
Signal Used: LEX: MADOCA & L6

NavIC / IRNSS

Navigation with Indian Constellation

Indian Regional Navigation Satellite System

NavIC Signal Types

Signal	Carrier Frequency	Bandwidth
L5	1176.45MHz	24MHz
S	2492.028MHz	16.5MHz

Please check the following site for the latest updates:

<https://www.unoosa.org/oosa/en/ourwork/icg/annual-meetings.html>

See file 01_NAVIC_ICG_2019.pdf for the latest information as per DEC 2019

NavIC (Navigation with Indian Constellation)

- **Consists of 7 Satellites**
- **4 Geo Synchronous Orbit (GSO) satellites**
 - **at 55°E and 111.75°E at an inclination of 27°**
- **3 Geo Stationary Satellites (GEO)**
 - **at 32.5°E, 83°E and 129.5° E at an inclination of 5°**
- **Transmits signals in L5 band (1176.45MHz) and S band (2492.028MHz)**

Please check the following site for the latest updates:

<https://www.unoosa.org/oosa/en/ourwork/icg/annual-meetings.html>

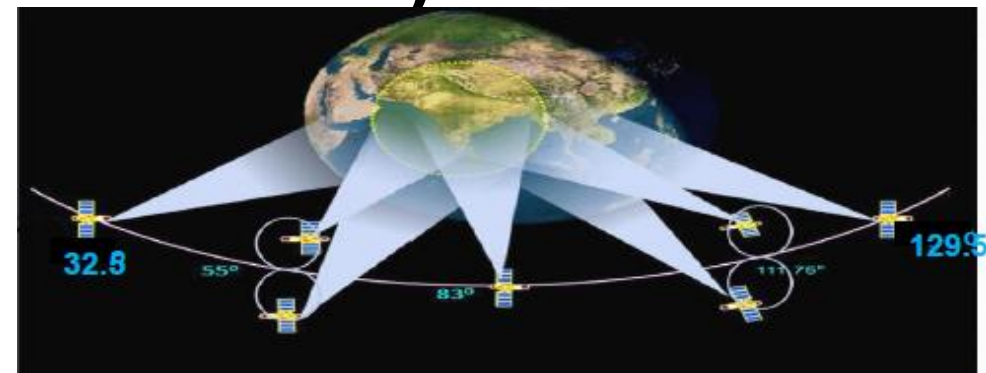

NavIC Space Segment

- All Seven Satellites are successfully realized in orbit
- IRNSS-1A (1 July 2013) IRNSS-1B (4 Apr 2014)
- IRNSS-1C (10 Nov 2014) IRNSS-1D (28 Mar 2015)
- IRNSS-1E (20 Jan 2016) IRNSS-1F (10 Mar 2016)
- IRNSS-1G (28 Apr 2016) IRNSS-1I (12 Apr 2018)

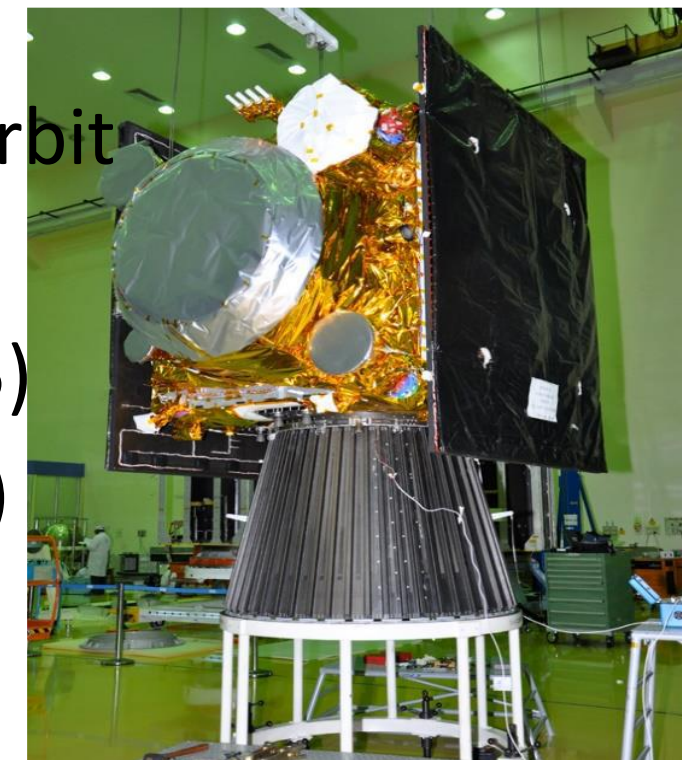

Multi GNSS Issues

- In the past we had only GPS & GLONASS, now we have Galileo, BeiDou, QZSS, IRNSS
- Compatibility
 - Lets not hurt each other
 - Interference issues
- Interoperable
 - I'll use yours, you can use mine
 - Use of the same receiver and antenna to receive different signals
- Interchangeable
 - Any four will do
 - Can ONE GPS, ONE GLONASS, ONE Galileo and ONE COMPASS provide 3D Position?

Multi-GNSS Signals

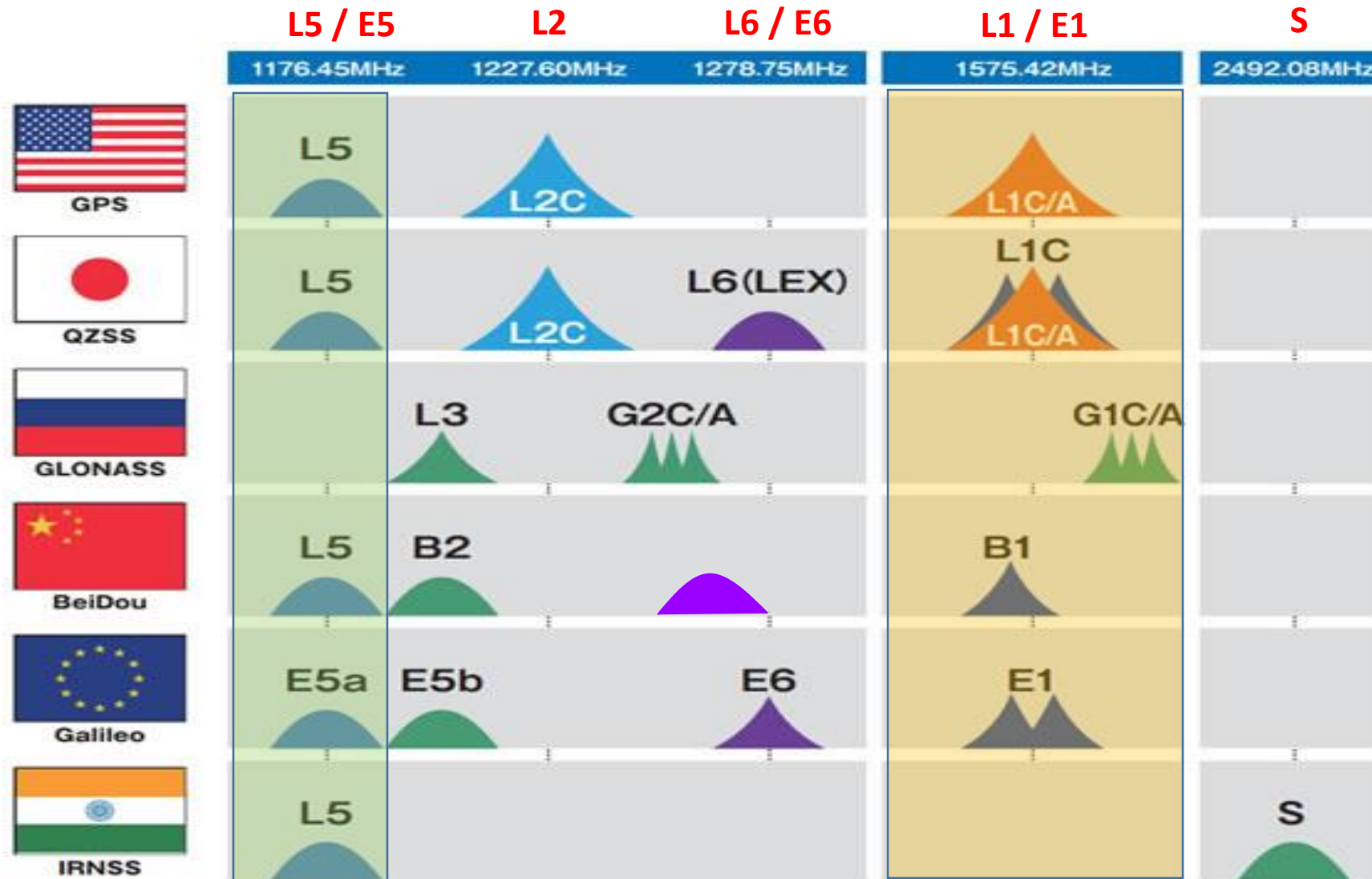

Multi GNSS Signals: Benefits to Users

- GPS+GLONASS+Galileo+COMPASS+IRNSS+QZSS
- Asia-Oceanic region will see the maximum number of satellites

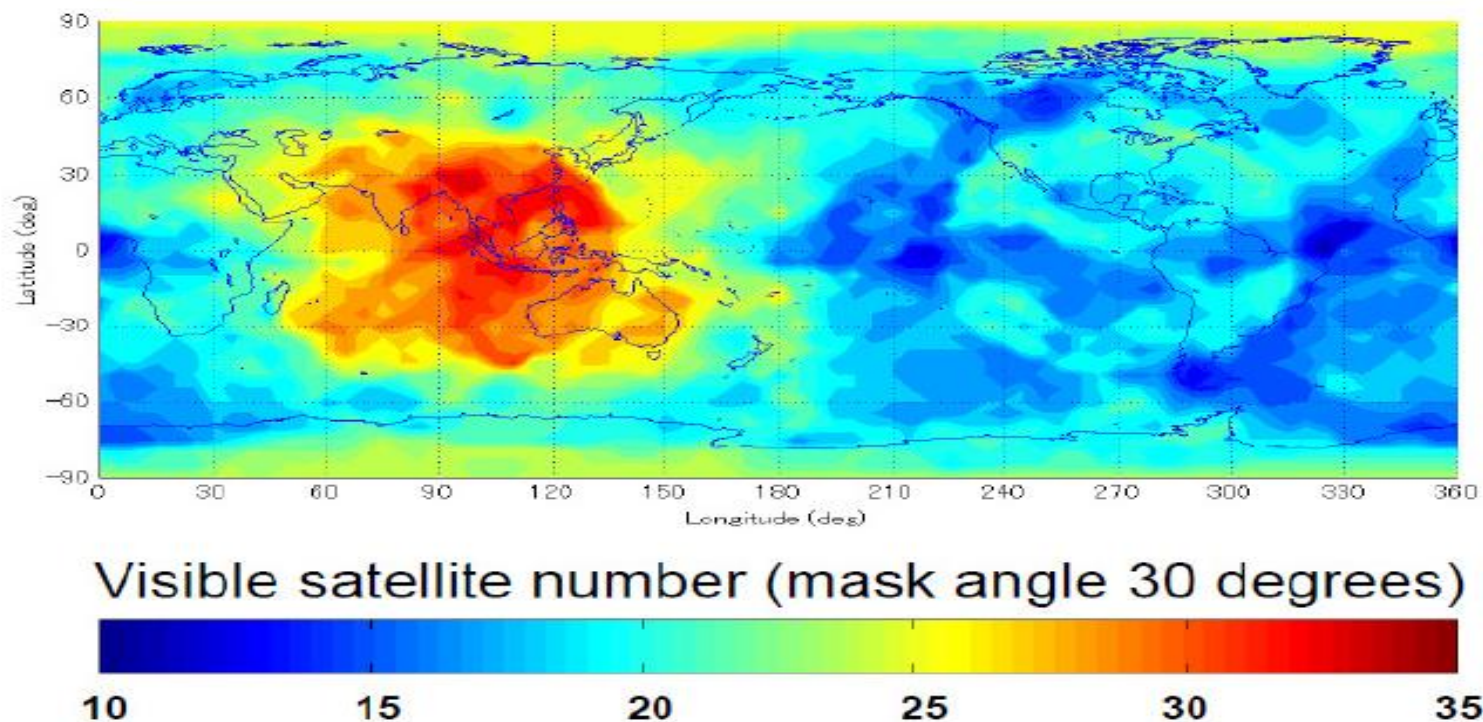

Multi GNSS Signals: Benefits to Users

- Increase in usable SVs, signals and frequencies
 - Increase in availability and coverage
 - More robust and reliable services
 - Higher accuracy in bad conditions
 - Less expensive high-end services
 - Better atmospheric correction
- Emerging new and expanding existing applications are to be expected
 - Atmosphere related applications
 - Short Message Broadcasting
 - SAR (Search And Rescue Applications)
 - Bi-static Remote Sensing
 - Compute Soil Moisture, Wind Velocity, Sea Wave Height etc...