

An Introduction to Global Navigation Satellite Systems

Ben Ashman

Navigation and Mission Design Branch

Goddard Space Flight Center, Greenbelt, MD

Navigation Satellite Concept and History

Navigation

- Navigation is the process of determining position and direction
- Generalization of the problem: estimate unknown parameters based on related observations

$$\mathbf{z} = \mathbf{h}(\boldsymbol{\theta}) + \mathbf{v}$$

$\boldsymbol{\theta}$ = parameter vector (e.g., Cartesian position and velocity, our “state”)

\mathbf{Z} = observation vector (i.e., set of measurements)

\mathbf{v} = observation noise vector (i.e., measurement error)

$\mathbf{h}(\cdot)$ = relation between parameter set and observation set (i.e., measurement model)

- Given a parameter set, we seek an observation set, a relation between our parameters and observations, and an estimator $\hat{\boldsymbol{\theta}}(\cdot)$, in order to form an estimate: $\hat{\boldsymbol{\theta}} = \hat{\boldsymbol{\theta}}(\mathbf{z})$
- Elegant and effective solutions have been devised by humans and other species for millennia

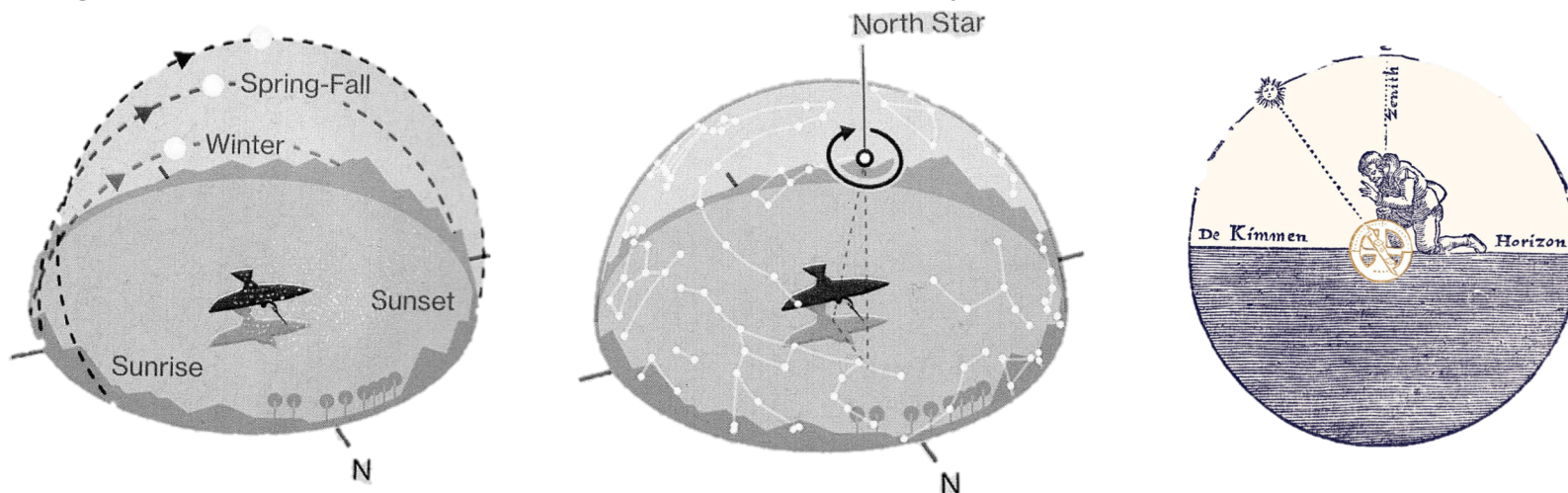

Navigation (continued)

- **Relative navigation**

Dead reckoning: monitor rate of travel and heading using a compass; prone to error, especially at sea

Landmark bearings: angles to two known landmarks will constrain position in two dimensions

- **Absolute navigation: latitude and longitude (clocks vs. celestial)**

Latitude: Measure the elevation of pole star above the horizon with a sextant or astrolabe

Longitude: Very good clock or celestial (sextant for the elevation of celestial bodies above the horizon, accurate clock to determine the time of observations, almanac to find the predicted position of the body, magnetic compass to determine azimuth and maintain course continuity between celestial observations)

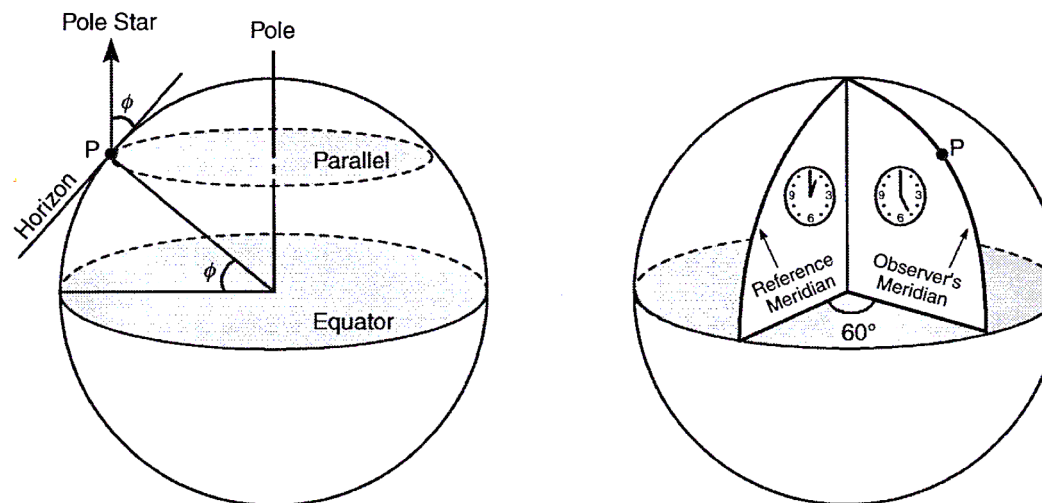

Latitude (left) and longitude (right) [1]

Radionavigation

- Measurements: *distances* from known transmitter locations via the measurement of radio frequency signal transit time
- Solution to the estimation problem: *trilateration*, the determination of absolute or relative locations of points by measurement of distances using the geometry of circles, spheres, or triangles
- Ground based:
LORAN (1940s), Omega (1960s)
- Satellite-based:
Sputnik I (1957), Parus and Tskikada, Transit, MOSAIC, and SECOR (1960s)

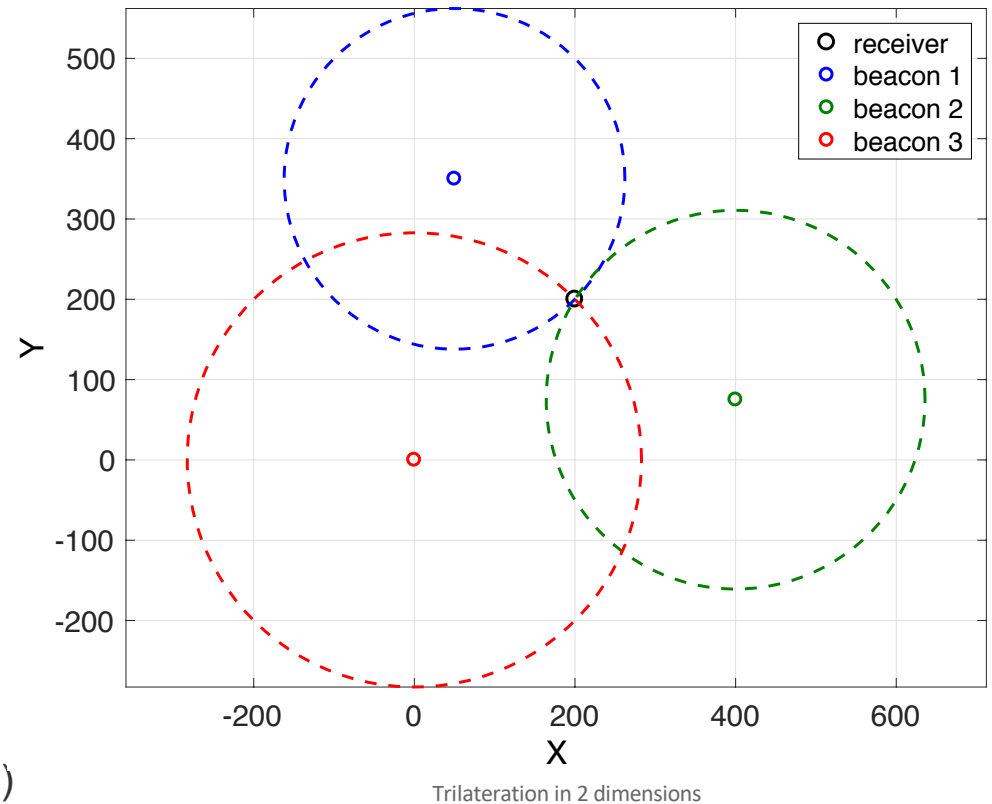

GNSS

- Global Navigation Satellite Systems (GNSS): radionavigation perfected
- Features

Accuracy: 3D accuracies of a few meters and down to millimeters for users with specialized equipment and processing

Availability: signal availability anywhere on Earth with a clear view of the sky

Integrity: the assurance that expected performance will be realized

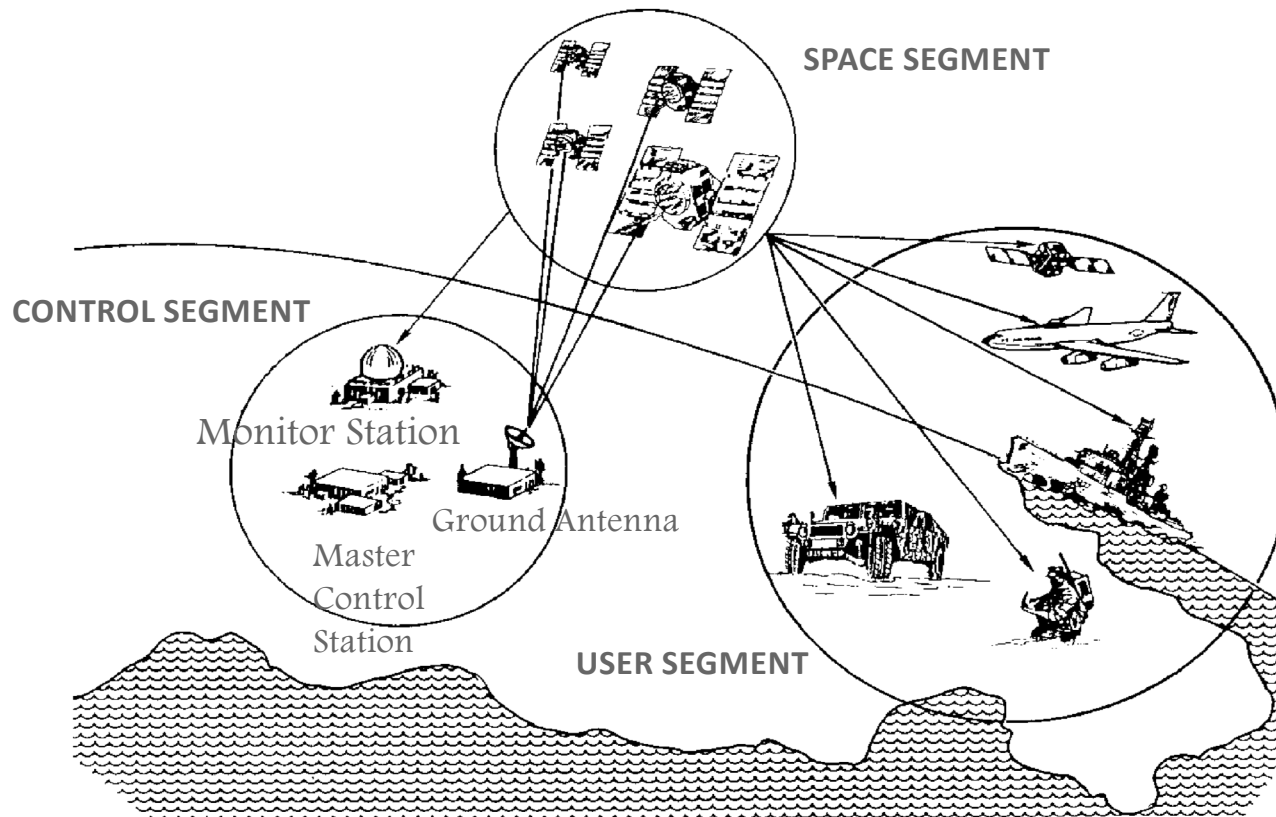

GNSS (continued)

- Space segment
 - Constellation of satellites in near-circular, Medium Earth Orbits (~20,000 km) or Geosynchronous Earth Orbits (~36,000 km), each satellite equipped with atomic clocks
- Control segment
 - Network of ground stations and antennas that perform monitoring of the constellation, check for anomalies, generate new orbit and clock predictions, build and send upload to spacecraft
- User segment
 - GNSS receivers—specialized radios that track GNSS signals and produce position and velocity solutions, typically with low-cost clocks

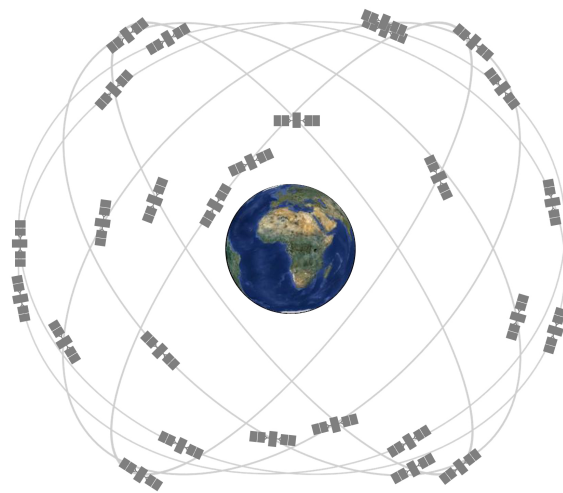

GPS Space Segment [4]

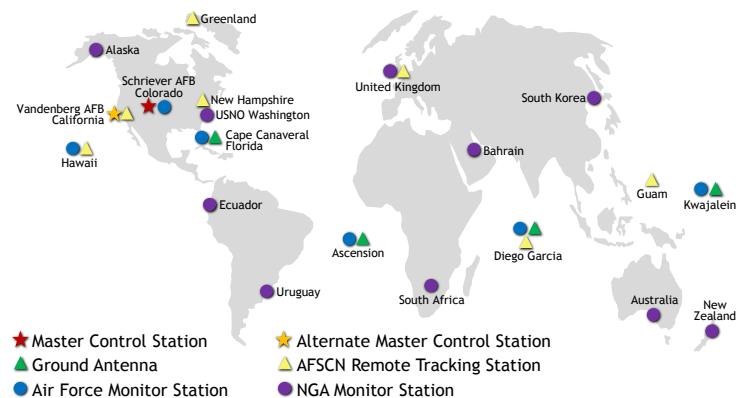

GPS Control Segment [5]



GPS Receivers [6]

GNSS applications

- Applications of satellite navigation are everywhere
- Military
- Civilian
 - Transportation
 - Public services
 - Precise machine control
 - Timing and frequency
 - Surveying
 - Surveillance
 - Recreational Space
 - Scientific applications
- US spends about \$1.0B-\$1.5B on GPS annually
- Annual direct economic benefit estimated at about \$70B, 0.4% GDP*



*www.gmps.gov/governance/advisory/meetings/2015-06/Leveson.pdf

GNSS constellations

- GNSS is an umbrella term for satellite constellations that broadcast signals from space for radionavigation

Systems with global coverage: GPS (United States), Galileo (European Union), GLONASS (Russia), BeiDou (China)

Systems with regional coverage: NAVIC (India), QZSS (Japan)

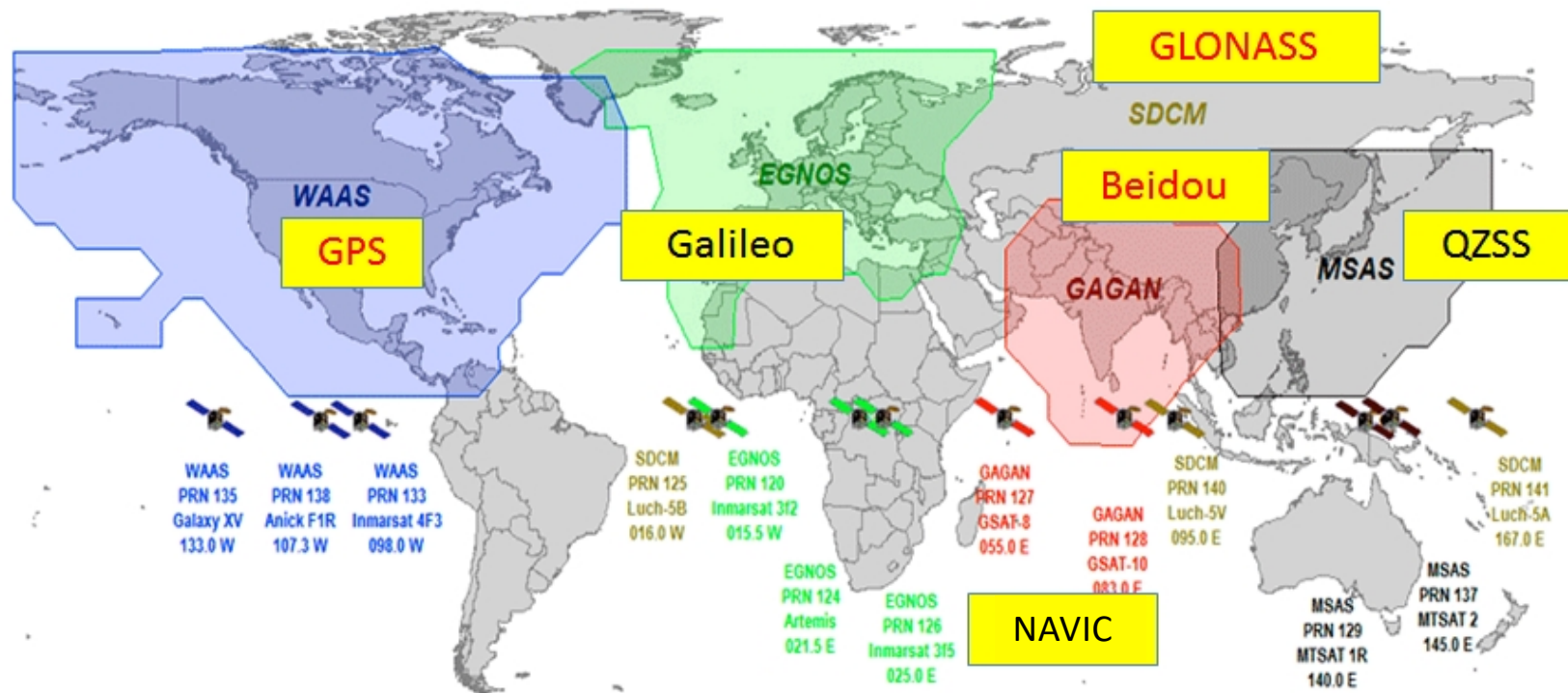

GNSS constellations, augmentations, and regional constellations [7]

Approximate GNSS Timeline

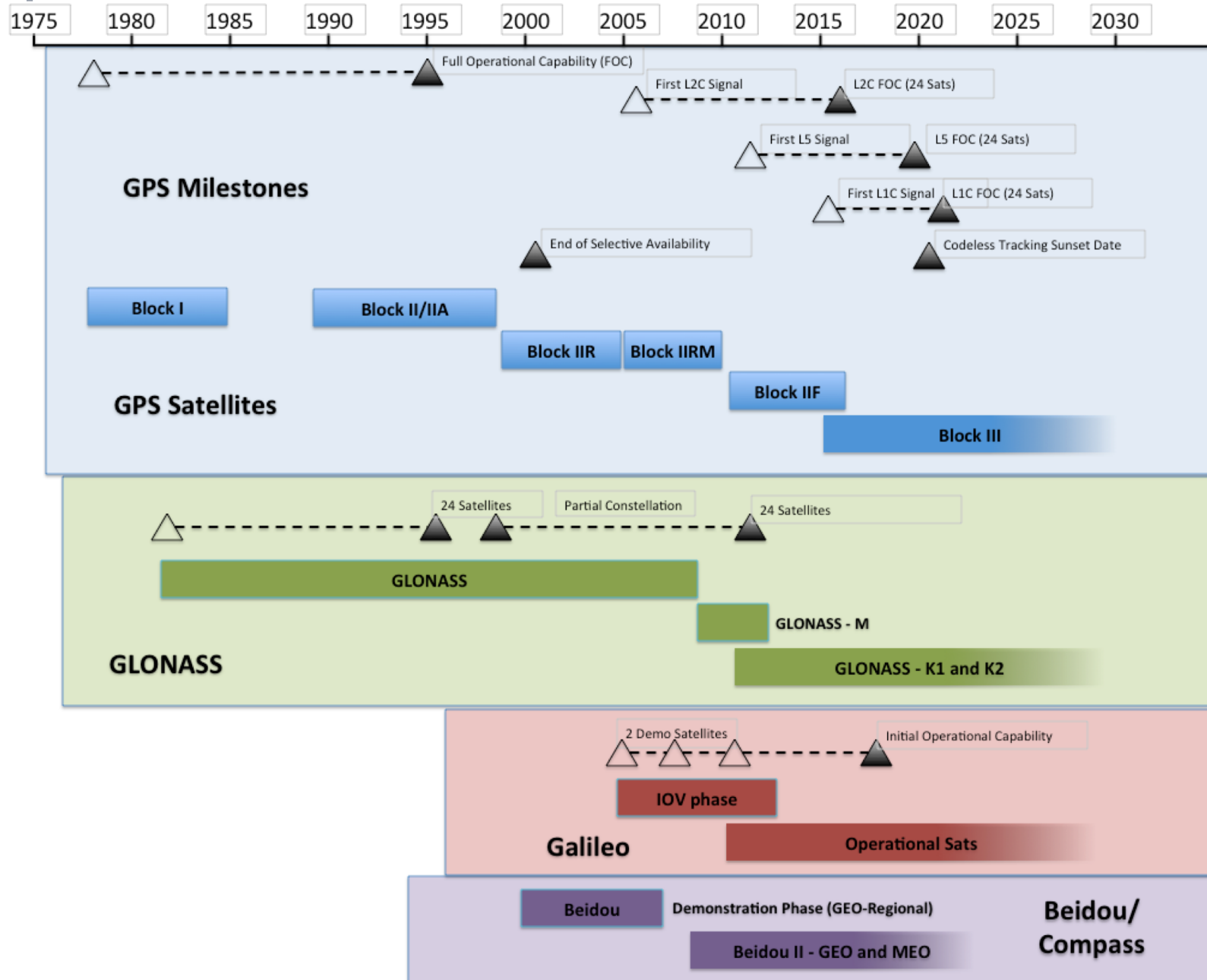

GNSS status and future development

GPS
US
(24+)



Galileo
EU
(27)

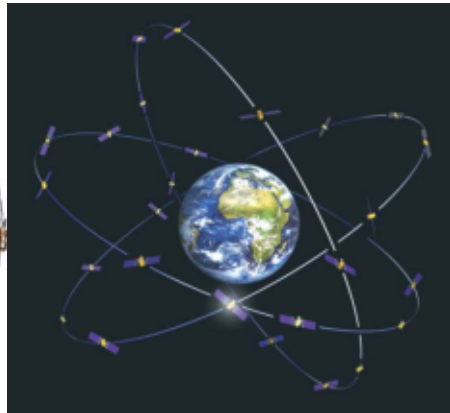

GLONASS
Russia
(24)

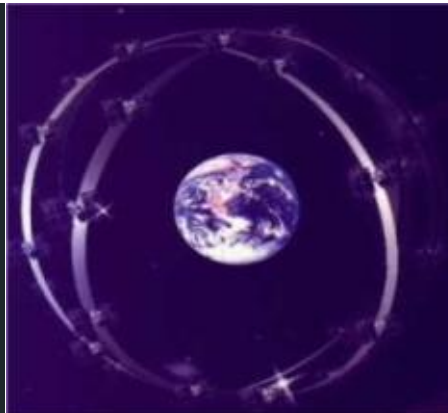

Beidou
China
(35)

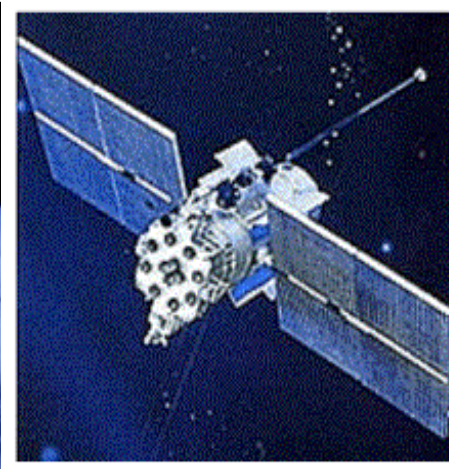

GNSS status and future development

- Status of current GNSS constellations

GPS (US) - Fully operational with global coverage since 1995, 31 satellites in orbit, GPSIII SV01 available for launch and SV01-10, issued a request for proposals in February 2018 for the next block of satellites, GPS IIF, awarded to Lockheed Martin Sept. 2018

GLONASS (Russia) – Full operational capacity / global coverage achieved in 1995, lost and then regained in 2011, 23 satellites currently operational, modernization efforts underway

Galileo (European Union) – First launch in 2005, full operational capacity expected in 2020 with 27+ satellites, initial services available now with 16 full operational satellites in orbit

BeiDou (China) – currently providing service in Asia-Pacific, expected to reach global coverage in 2020 with 35 satellites, includes MEO, HEO, and GEO sats.

NAVIC – Provides service to India region with GEO/GSO satellites, now operational, 7 satellites

QZSS – Provides service to Japan region, HEO orbits for improved performance in urban canyons, compatible with GPS, operational status in late 2018 with 4 satellites, future expansion planned.

SBAS – Numerous regional Satellite Based Augmentation Systems (SBAS), e.g., WAAS, EGNOS, SDCM, enhance GPS performance and integrity especially for civil aviation

- International collaboration is facilitated through the International Committee on GNSS (ICG) and other forums with the objective of inter-operability among the different constellations

Satellite-based augmentation systems (SBAS)

- Wide Area Augmentation System (WAAS)
 - Commissioned in 2003 and operated by the U.S. Federal Aviation Administration (FAA), to enable aircraft navigation in the U.S. National Airspace System (NAS)
- European Geostationary Navigation Overlay System (EGNOS)
 - Three geostationary satellites and a network of ground stations
 - Augments the US GPS satellite navigation system in Europe
- Japan's Multifunction-Transport-Satellite Satellite Augmentation System (MSAS)
 - MSAS for aviation use was commissioned in 2007
- India's GPS and Geo-Augmented Navigation System (GAGAN)
- Russian System of Differential Corrections and Monitoring (SDCM)

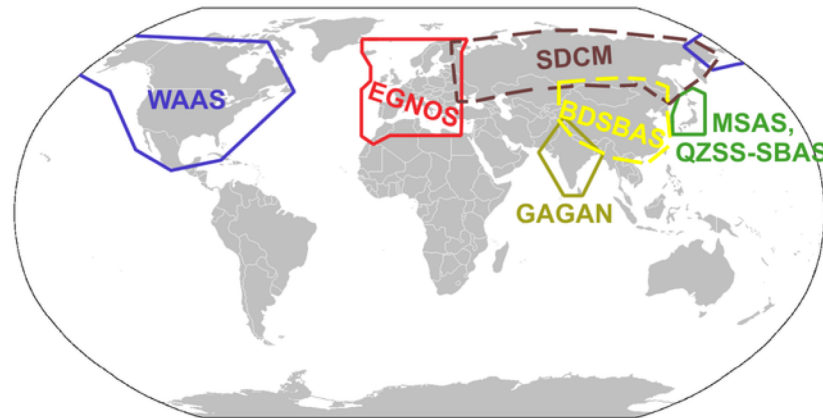

SBAS: Satellite-based GNSS augmentations [23]

Other augmentations

- Nationwide Differential GPS System (NDGPS):

Ground-based augmentation system of ~80 sites operated by the U.S. Coast Guard, Federal Railroad Administration, and Federal Highway Administration, to provide increased accuracy and integrity to U.S. users on land and water.

- Local Area Augmentation System (LAAS):

Augmentation to GPS that focuses its service on the airport area (approximately a 20-30 mile radius)

Broadcasts correction message via a very high frequency (VHF) radio data link from a ground-based transmitter

LAAS is a US activity led by the FAA, but other nations are developing their own ground based augmentation system projects

- NASA Global Differential GPS (GDGPS) System:

GDGPS is a commercial high accuracy (~ 10cm) GPS augmentation system, developed by the Jet Propulsion Laboratory (JPL) to support real-time positioning, timing, and orbit determination requirements.

International coordination

- International coordination is critical to ensure compatibility and interoperability
- US has bilateral agreements or joint statements with all major international GNSS service providers
- International committee on GNSS (ICG) Established in 2005 under the umbrella of the United Nations to provide forum for discussion

Purpose is to promote voluntary cooperation on matters of mutual interest in order to ensure greater compatibility, interoperability, and transparency among GNSS systems

13th ICG held in Xi'an, China in November 2018



Benjamin Ashman, Ph.D.

Navigation and Mission Design Branch

Code 595, NASA Goddard Space Flight Center

Greenbelt, MD 20771

benjamin.w.ashman@nasa.gov

GPS Introduction

GPS history

- Developed by the US Department of Defense
 - Early GPS program driver was Trident Missile Program (Submarine launched ICBM)
 - Satellites carry a nuclear detonation detection payload
- Early satellite navigation systems
 - TRANSIT (Doppler positioning)
 - Timation (first atomic frequency standards flown in space)
 - USAF 621B Program (use of PRN codes for ranging)
- First prototype GPS satellite launched in 1978
- First Block II (Operational) GPS satellite launched 1989
- Full Operational Capability declared in 1994

Current GPS constellation status

- 31 space vehicles currently in operation
 - 0 GPS IIA
 - 12 GPS IIR
 - 7 GPS IIR-M
 - 12 IIF
- several additional satellites in residual status
- Continuously assessing constellation health to determine launch need
- Global GPS civil service performance commitment met continuously since Dec 1993

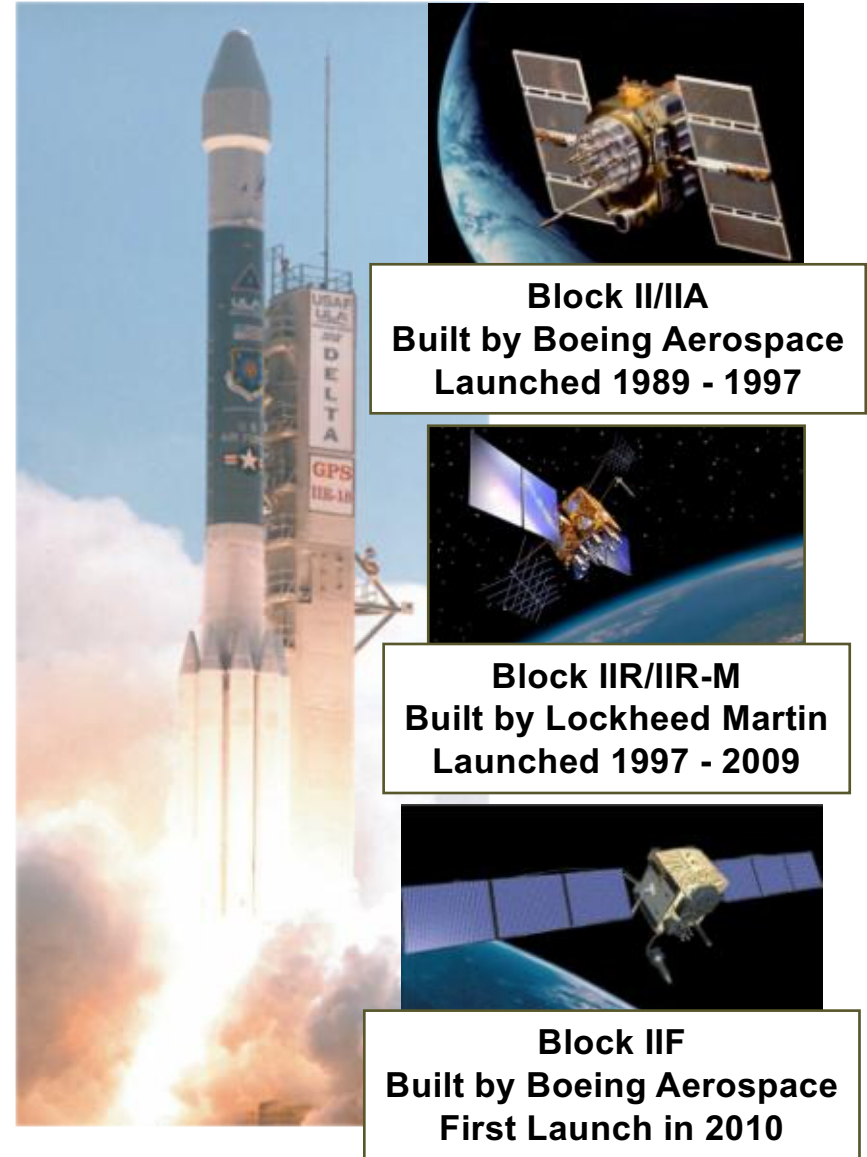

GPS – three segments

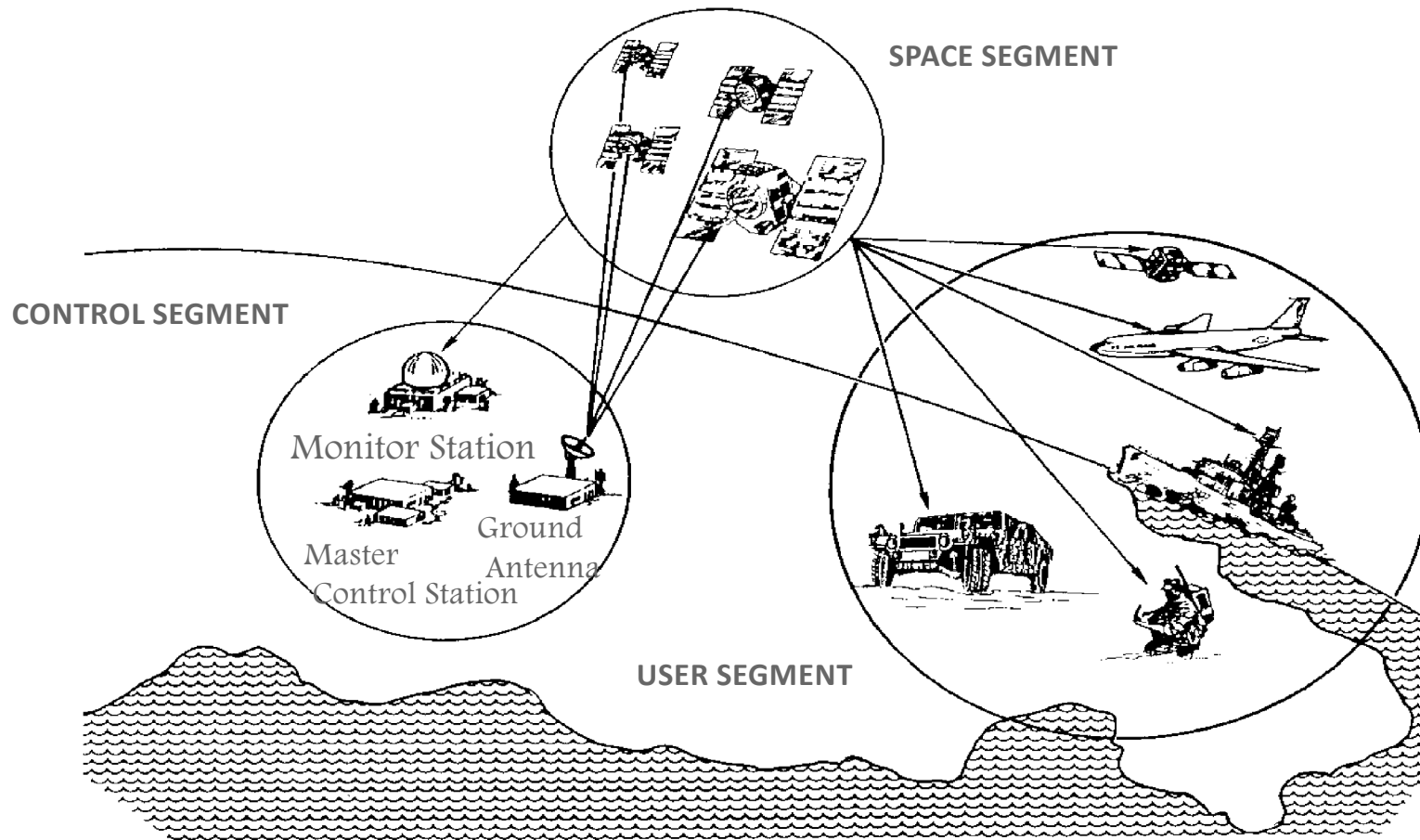

GPS space segment

- Nominal 24 satellite constellation

Semi-synchronous, circular orbits
(~20,200 km/10,900 nautical
miles altitude)

Repeating ground tracks
(11 hours 58 minutes)

Six orbital planes, inclined at 55
degrees, four vehicles per plane

➤ *Designed for global coverage (at least 4 sats in view)*

- Redundant cesium and/or rubidium clocks on board each satellite
- There have been 1-4 replenishment launches per year in recent years

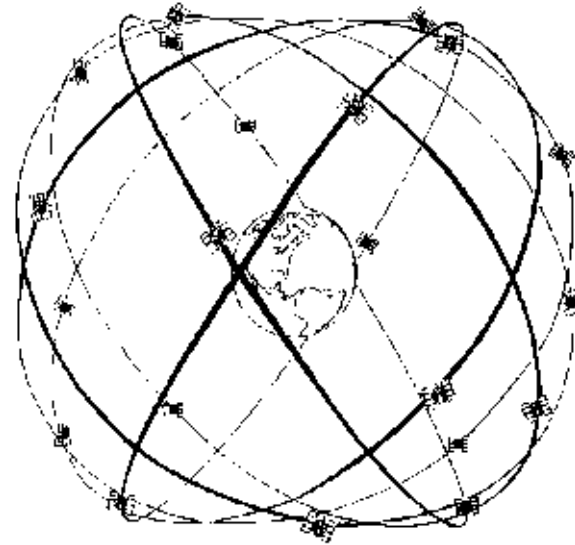

GPS control segment

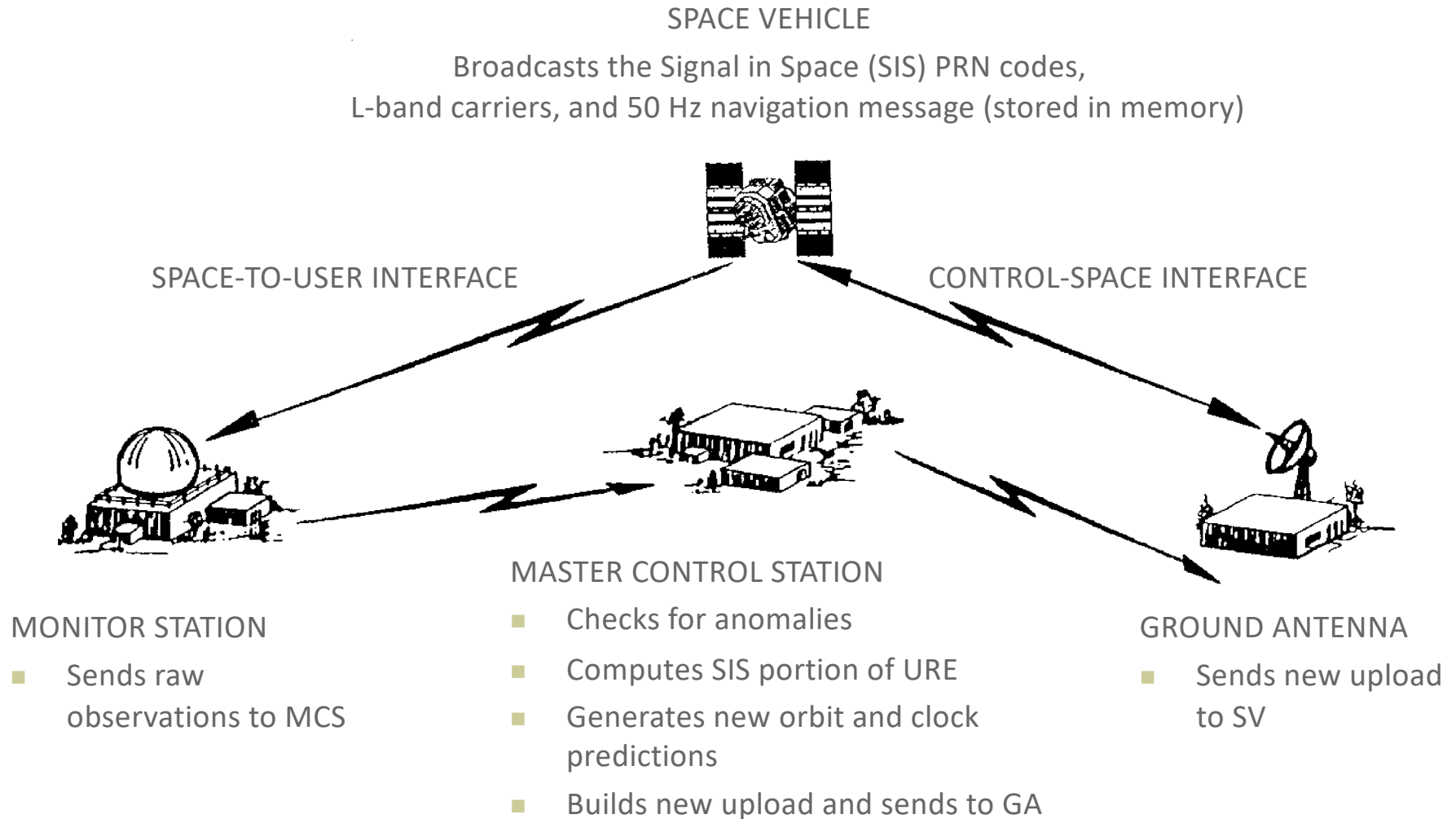

GPS control segment (cont.)

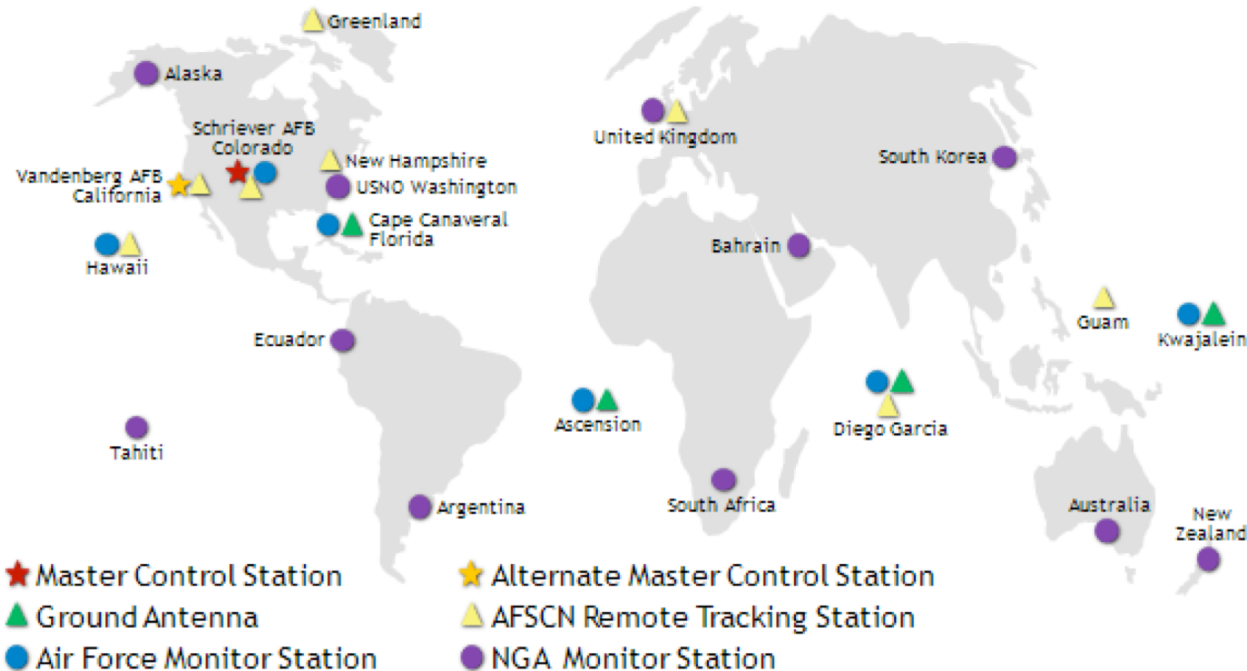

- The current operational control segment includes a master control station, an alternate master control station, 12 command and control antennas, and 16 monitoring sites.
- Data from Air Force and NGA monitor stations incorporated into Control Segment Kalman filter solution.

GPS user segment

- GPS receivers are specialized “radios” that track GPS signals and produce position and velocity solutions

Wide range of cost/sophistication depending on the application

- Signals from 4 or more GPS satellites are required, but 8-10 are typically available at any time
- Low cost civil (SPS) receivers typically track only the L1 C/A signal
- Precise Positioning Service receivers have special keys that allow tracking of the encrypted military codes transmitted on L1 and L2 signals
- High performance civil receivers use special techniques to track the legacy military signals and now track new signals provided by GPS and other GNSS systems

Military Spacecraft
(~\$2,000,000)

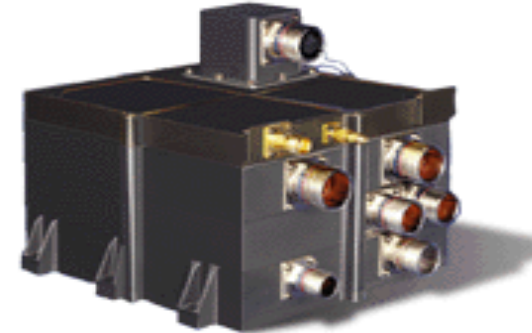

Consumer/Recreation
(~\$100-500)



Legacy GPS signal structure

- **Two L-band carrier frequencies**

L1 = 1575.42 MHz L2 = 1227.60 MHz

- **Two PRN Codes – Uniquely Identify Each Satellite**

C/A: Coarse Acquisition (Civilian) Code

- » Broadcast only on L1 carrier
- » Available to all users
- » Short code simplifies acquisition

P(Y): Military Code

- » Encrypted code sequence
- » Available only to *authorized* users on both L1 and L2 carriers
- » Improved performance, jam resistance

- **PRN Codes are modulated with Navigation Message Data**

Provides ephemeris data and clock corrections for the GPS satellites and additional info

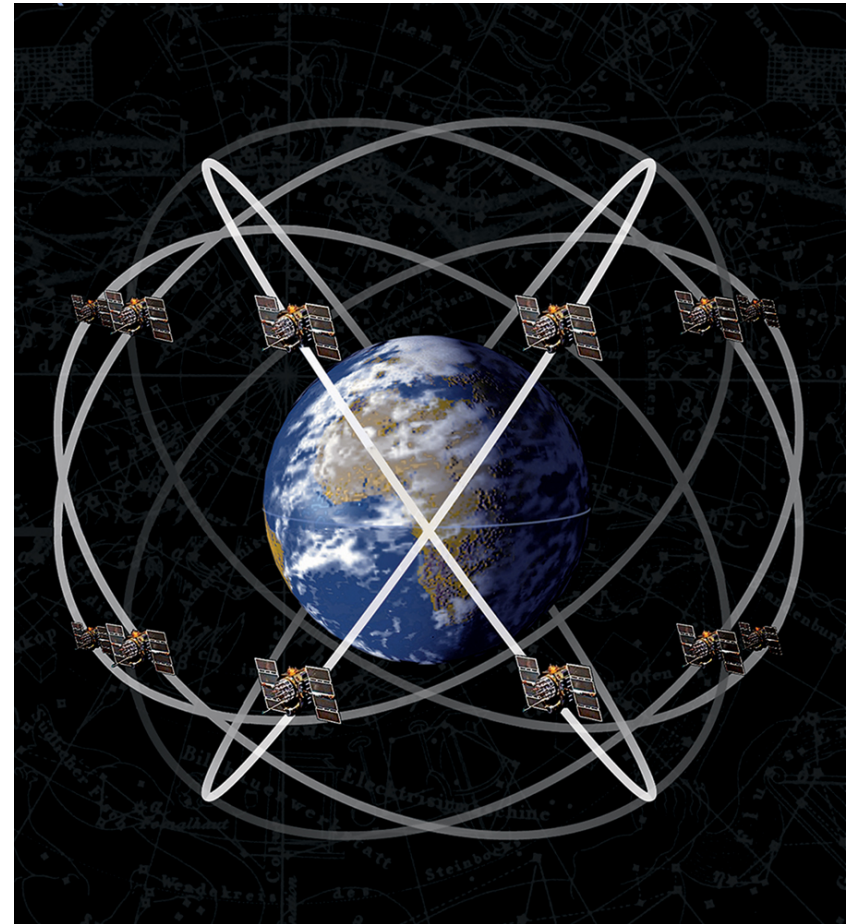

Baseline GPS constellation [24]

GPS modernization

- Goals

System-wide improvements in:

- » Accuracy
- » Availability
- » Integrity

Robustness against interference

Improved indoor, mobile, and urban use

Interoperability with other GNSS constellations

Backward compatibility

- Achieved through

Modernized Space and Ground segments

New signals

Improved “CNAV” data message

GPS modernization: new civil signals

- L2C @ 1227.60 MHz = 120×10.23 MHz (GPS IIR-M 2005)
 - Allows ionospheric error removal for civilian users
 - Two time-multiplexed PRN codes, one is dataless
- L5 @ 1176.45 MHz = 115×10.23 MHz (GPS IIF 2009)
 - Designed for safety of life applications
 - In highly protected ARNS band
- L1C @ 1575.42 MHz = 154×10.23 MHz (GPS III 2018)
 - Interoperable with other GNSS systems
 - Multiplexed Binary Offset Carrier modulation reduces interference with L1C/A, may allow higher accuracy tracking
- All modulated with improved CNAV or CNAV-2 packetized data message with forward error coding.
 - First demonstration conducted in Jun 2013.
 - Pre-operational CNAV now continuously broadcast with daily updates.

GPS modernization: spectrum

Block IIA 1990 Block IIR 1997



Block IIR-M, 2005



Block IIF, 2009



Block III, 2014

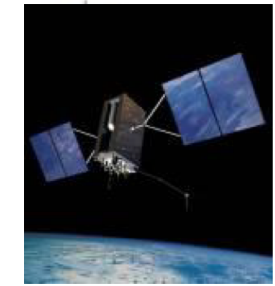

Legacy Signals →

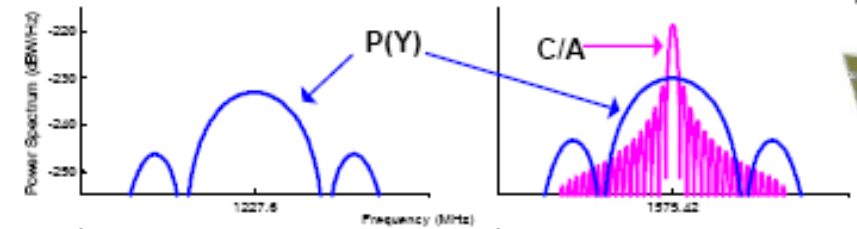

As of 4/2017:
L2C broadcast from 19 satellites
L5 broadcast from 12 satellites

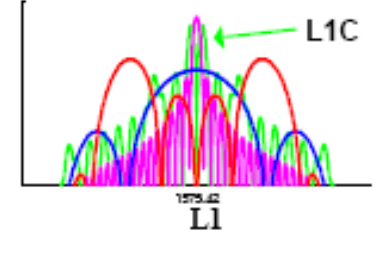
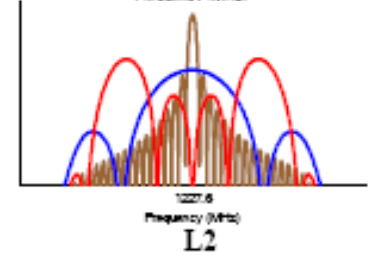
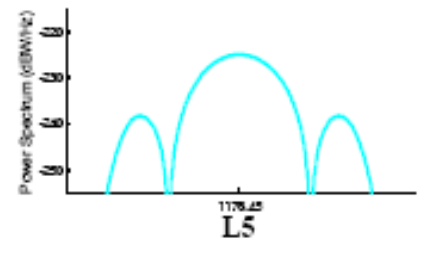
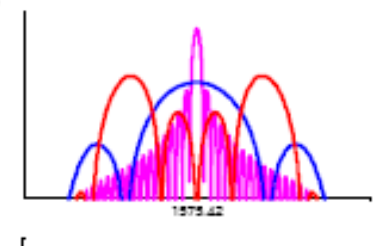
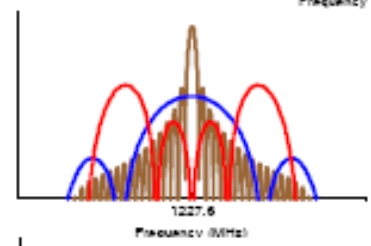
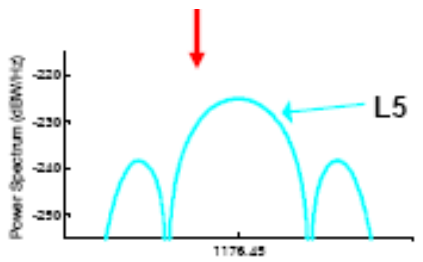
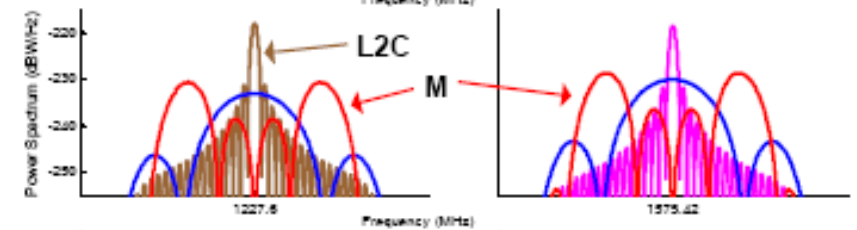





ARNS Band

RNSS Band

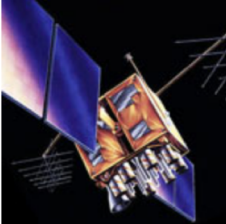
ARNS Band

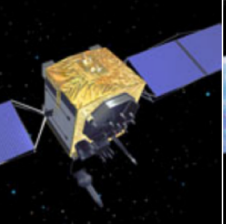
GPS modernization: space segment status

LEGACY SATELLITES		MODERNIZED SATELLITES		
				
BLOCK IIA	BLOCK IIR	BLOCK IIR-M	BLOCK IIF	GPS III/IIF
0 operational	12 operational	7 operational	12 operational	In production
<ul style="list-style-type: none"> ▪ Coarse Acquisition (C/A) code on L1 frequency for civil users ▪ Precise P(Y) code on L1 & L2 frequencies for military users ▪ 7.5-year design lifespan ▪ Launched in 1990-1997 ▪ Last one decommissioned in 2016 	<ul style="list-style-type: none"> ▪ C/A code on L1 ▪ P(Y) code on L1 & L2 ▪ On-board clock monitoring ▪ 7.5-year design lifespan ▪ Launched in 1997-2004 <p>LEARN MORE ABOUT GPS IIR AT AF.MIL ➔</p>	<ul style="list-style-type: none"> ▪ All legacy signals ▪ 2nd civil signal on L2 (L2C) LEARN MORE ➔ ▪ New military M code signals for enhanced jam resistance ▪ Flexible power levels for military signals ▪ 7.5-year design lifespan ▪ Launched in 2005-2009 <p>LEARN MORE ABOUT GPS IIR-M AT AF.MIL ➔</p>	<ul style="list-style-type: none"> ▪ All Block IIR-M signals ▪ 3rd civil signal on L5 frequency (L5) LEARN MORE ➔ ▪ Advanced atomic clocks ▪ Improved accuracy, signal strength, and quality ▪ 12-year design lifespan ▪ Launched in 2010-2016 <p>LEARN MORE ABOUT GPS IIF AT AF.MIL ➔</p>	<ul style="list-style-type: none"> ▪ All Block IIF signals ▪ 4th civil signal on L1 (L1C) LEARN MORE ➔ ▪ Enhanced signal reliability, accuracy, and integrity ▪ No Selective Availability LEARN MORE ➔ ▪ 15-year design lifespan ▪ IIF: laser reflectors; search & rescue payload ▪ First launch in 2018 <p>LEARN MORE ABOUT GPS III AT AF.MIL ➔</p>

<https://www.gps.gov/systems/gps/space/#generations>

GPS modernization: ground segment

- Legacy ground system is known as the Operational Control System (**OCS**). Several modernization efforts have been implemented or are in progress
- **L-AII**: Legacy Accuracy Improvement Initiative (completed 2008)
 - Added 10 NGA monitoring sites to bring total to 16
- **AEP**: Architecture Evolution Plan (2007-current)
 - Broad OCS system upgrade. Manages current modernized constellation
- **LADO**: Launch and early orbit, Anomaly resolution, and Disposal Operations (fielded 2007)
 - Handles GPS satellites outside operational constellation
- **OCX**: Next Generation Operational Control Segment (contract awarded 2008, multiphase rollout 2017-2021)
 - Eventually replace OCS, control GPS III
- Risk Mitigations to late OCX delivery
 - COps**: GPS III Contingency Ops program (delivery in 2019)
 - » Enable GPS III's "IIF features" prior to OCX Block 1 (2021)
 - MCEU**: MCode Early Use - MCEU
 - » OCS upgrades to support MCode operational testing

GPS III Status

- Newest block of GPS satellites

First to broadcast common L1C signal

Multiple civil and military signals;

- » L1 C/A, L1 P(Y), L1M, L1C,
- » L2C, L2 P(Y), L2M,
- » L5

Three Rubidium clocks

First launch in ~2018 timeframe

- Lockheed Martin in Denver CO awarded contract for two (SV01/02) development and six operational satellites (SV03-08), with option for two more (SV09-10) exercised in 2016.
- GPS III SV11+ awarded to Lockheed Martin Sept. 2018. Will add:

Laser Retro-reflector Array

Search and Rescue payload



<http://gpsworld.com/2016-in-review-gps-navigates-the-future/>

GPS documentation

- System technical docs available on www.gps.gov
- GPS IS-200:
 - Spec. of legacy C/A & P codes and NAV message
 - Rev E and beyond adds L2C and CNAV
- GPS IS-800:
 - Specification of L5, and L5 CNAV
- SPS & PPS Performance standards
 - Defines the guaranteed level of performance in terms of Signal in Space (SIS) accuracy and Constellation design
 - Current system performance surpasses minimum spec and is improving.



Benjamin Ashman, Ph.D.

Navigation and Mission Design Branch

Code 595, NASA Goddard Space Flight Center

Greenbelt, MD 20771

benjamin.w.ashman@nasa.gov

GPS Space Applications



Space Uses of Global Navigation Satellite Systems (GNSS)



- Real-time On-Board Navigation: Precision formation flying, rendezvous & docking, station-keeping, Geosynchronous Orbit (GEO) satellite servicing
- Earth Sciences: GPS as a measurement for atmospheric and ionospheric sciences, geodesy, and geodynamics
- Launch Vehicle Range Operations: Automated launch vehicle flight termination; providing safety net during launch failures & enabling higher cadence launch facility use
- Attitude Determination: Some missions, such as the International Space Station (ISS) are equipped to use GPS/GNSS to meet their attitude determination requirements
- Time Synchronization: Support precise time-tagging of science observations and synchronization of on-board clocks

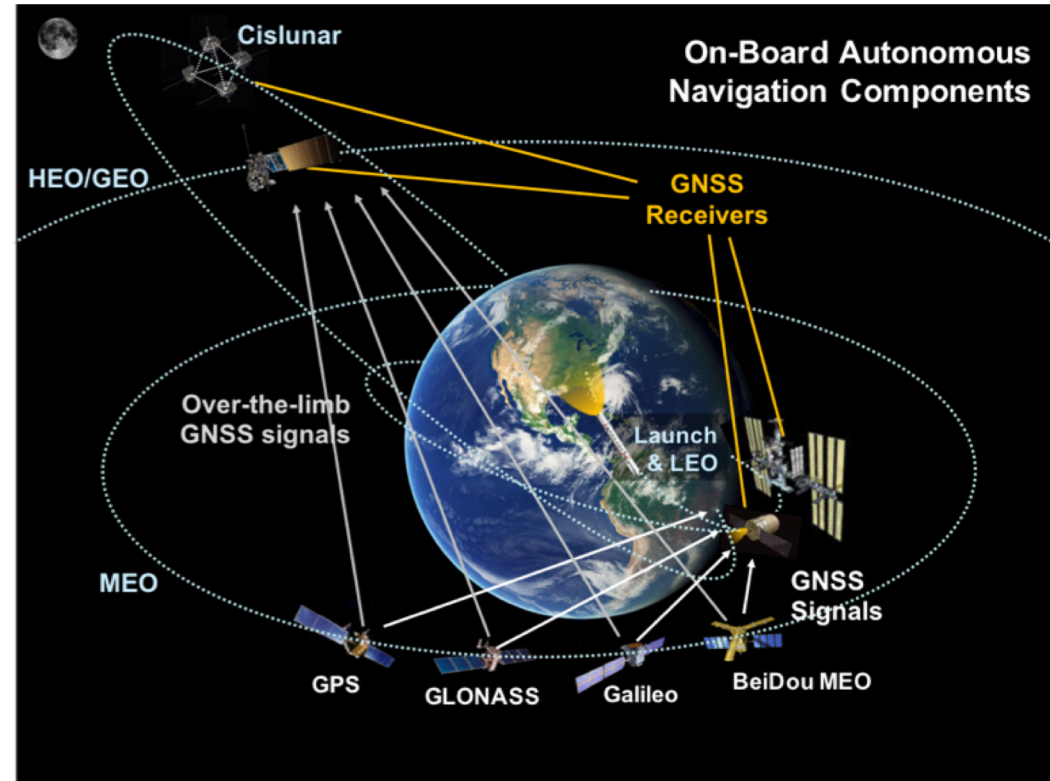

GPS capabilities to support space users will be further improved by pursuing compatibility and interoperability with GNSS

Main radiometric instrument:

NASA/JPL
BlackJack GPS receiver modified to track gravity-sensing crosslinks, and to form star-camera solutions, while producing cm-level POD and 0.1 nanosecond relative time transfer.

The Onera accelerometer was also required to produce accurate gravity maps.

15 YEARS OF GRACE

2 satellites **137** miles apart

2,384,052,480 miles traveled

Ice loss measured

3,400 GIGATONS GREENLAND

1,550 GIGATONS ANTARCTICA

1 gigaton =
1 kilometer by
1 kilometer cube

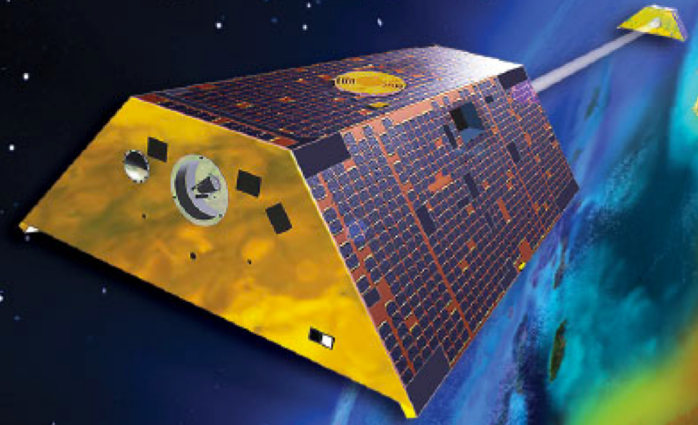

(image credit: NASA)
National Aeronautics and Space Administration



Results from GRACE

GRACE data have significantly improved understanding of: the global water cycle, mass and energy exchange within and between the Earth System components, the changes in ocean mass, the changing dynamics of polar ice caps and large continental aquifers and improved the prospects for assimilation of mass change data into climate models.

Examples of science applications include:

Sea level change

Surface and Deep Ocean Currents

Ocean heat storage

Polar and continental ice sheet me

Earth system mass transport

Drought and flooding

Land surface total water storage

Modeling and assimilation



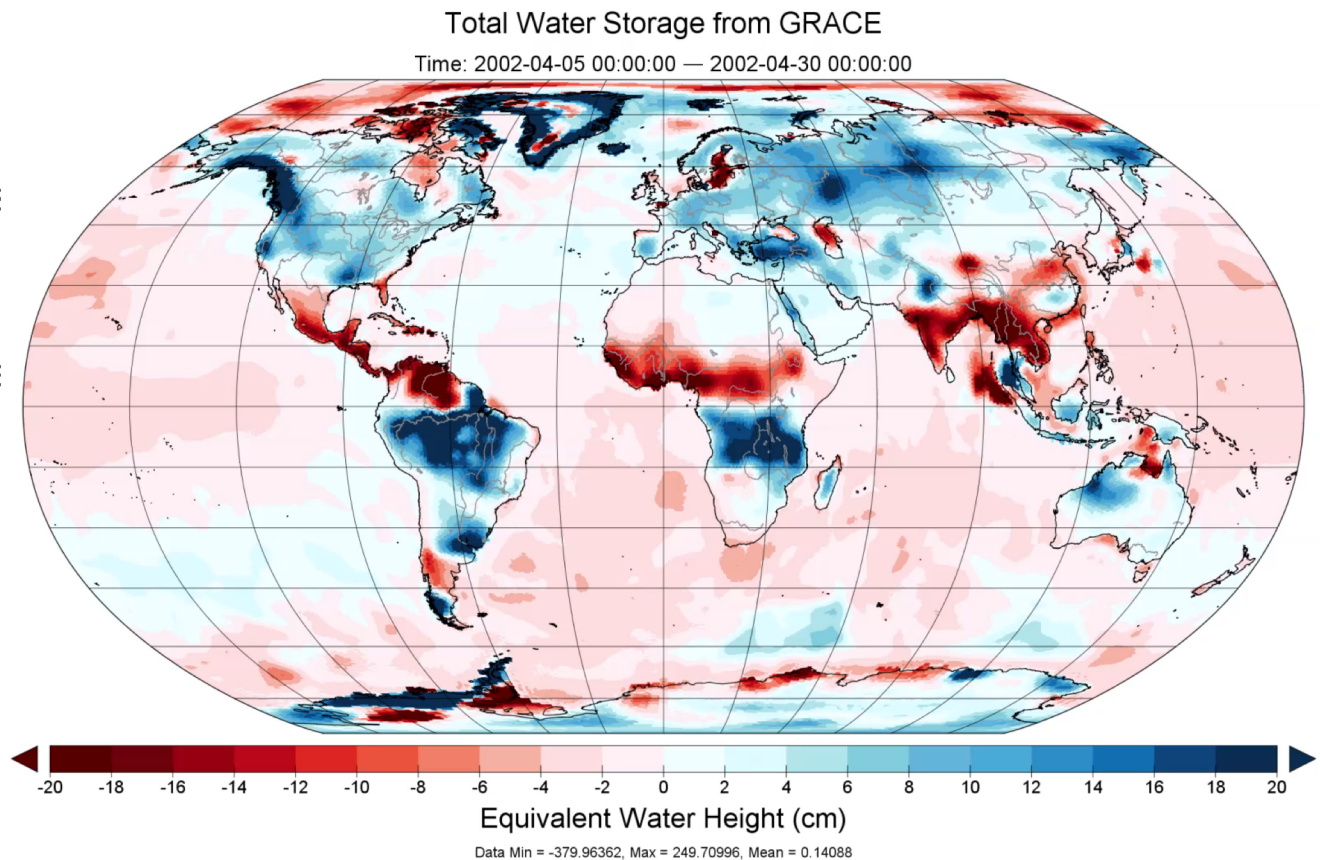





Earthquake assessment

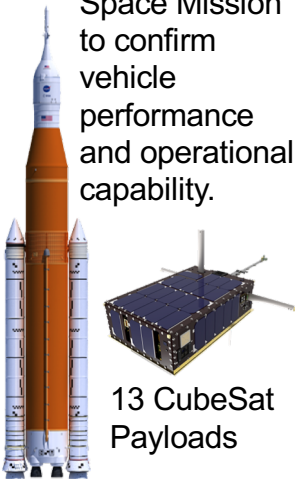

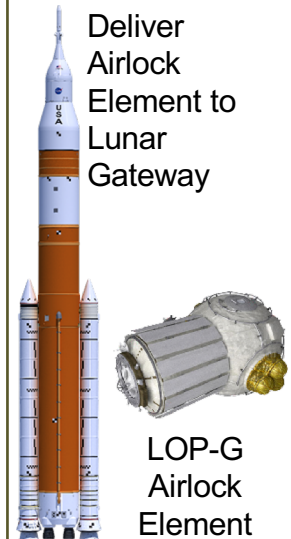

GPS use aboard Space Launch System

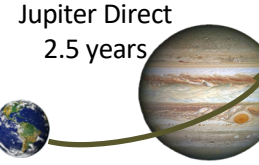
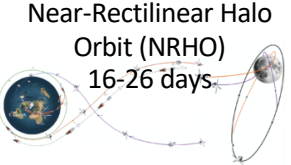
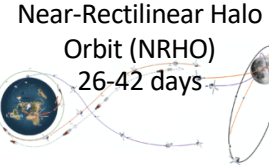

EM-1	EM-2	SM-1	EM-3	EM-4	EM-5
Exploration Mission 1	Exploration Mission 2	Science Mission 1	Exploration Mission 3	Exploration Mission 4	Exploration Mission 5
2021	2022	2023	2024	2025	2026
Block 1: ICPS	Block 1: ICPS	Block 1B Cargo	Block 1B: EUS	Block 1B: EUS	Block 1B: EUS
Cargo	4 Crew	Europa Clipper	4 Crew	4 Crew	4 Crew
<p>Cis-Lunar Space Mission to confirm vehicle performance and operational capability.</p>  <p>13 CubeSat Payloads</p>	<p>First crewed mission, to confirm vehicle performance and operational capability, same profile as EM-1.</p>  <p>Orion Capsule + Crew</p>	<p>First cargo mission configuration.</p>  <p>Europa Clipper to Jupiter</p>	<p>First Orion Docking to extract Habitat Module from EUS, deliver to Lunar Orbit Platform - Gateway</p>  <p>LOP-G Habitat Module</p>	<p>Deliver Logistics Module to Lunar Gateway</p>  <p>LOP-G Logistics Module</p>	<p>Deliver Airlock Element to Lunar Gateway</p>  <p>LOP-G Airlock Element</p>
<p>Cis-Lunar Trajectory 11-21 days</p> 	<p>Multi-TLI Lunar Free Return 8-21 days</p> 	<p>Jupiter Direct 2.5 years</p> 	<p>Near-Rectilinear Halo Orbit (NRHO) 16-26 days</p> 	<p>Near-Rectilinear Halo Orbit (NRHO) 26-42 days</p> 	<p>Near-Rectilinear Halo Orbit (NRHO) 26-42 days</p> 
<p>Honeywell SIGI with SPS Trimble Force 524D (L1 C/A Code Only) for Orbit Determination, Trans-Lunar Injection Burn and End-of-Mission disposal burn.</p>	<p>SIGI w/SPS Force 524D</p>	<p>Honeywell Mercury SPS for High-Alt SLS Vehicle Nav.</p>	<p>Honeywell Mercury SPS for High-Alt SLS Vehicle Nav.</p>	<p>Honeywell Mercury SPS for High-Alt SLS Vehicle Nav.</p>	<p>Honeywell Mercury SPS for High-Alt SLS Vehicle Nav.</p>



Restore-L



MISSION FACTS

LAUNCH DATE 2022

ORBIT: Polar low Earth orbit (LEO)

CLIENT: A satellite in LEO owned by the U.S. government

OPERATIONS: Autonomous rendezvous and grasping with telerobotic refueling and relocation

MANAGEMENT: The Space Technology Mission Directorate at NASA Headquarters and the Satellite Servicing Projects Division at NASA's Goddard Space Flight Center

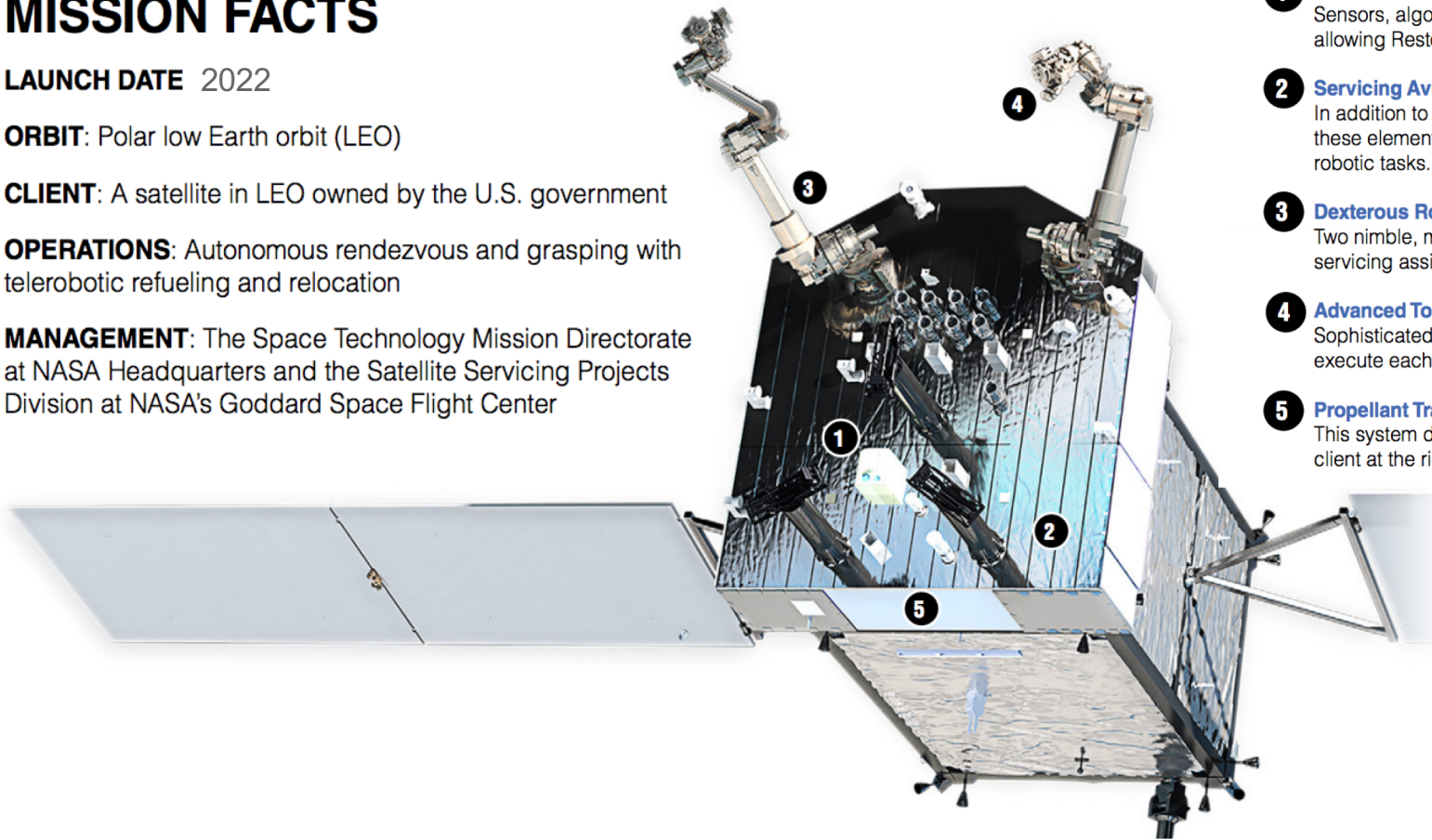

SERVICING TECHNOLOGIES

- 1 Autonomous, Real-Time Relative Navigation System**
Sensors, algorithms and processors join forces, allowing Restore-L to rendezvous safely with its client.
- 2 Servicing Avionics**
In addition to ingesting and crunching sensor data, these elements control Restore-L's rendezvous and robotic tasks.
- 3 Dexterous Robotic Arms**
Two nimble, maneuverable arms precisely execute servicing assignments. Software comes included.
- 4 Advanced Tool Drive And Tools**
Sophisticated, multifunction tools are manufactured to execute each servicing task.
- 5 Propellant Transfer System**
This system delivers measured amounts of fuel to the client at the right temperature, pressure and rate.

(image credit: NASA)

National Aeronautics and Space Administration



PACE

Plankton, Aerosol, Cloud, ocean Ecosystem

PACE MISSION

PACE will extend and improve NASA's 20 plus years of global satellite observations of our living ocean, atmospheric aerosols, and clouds and initiate an advanced set of climate-relevant data records. By determining the distribution of phytoplankton, PACE will help assess ocean health. It will also continue key measurements related to air quality and climate.

Science Goals

To extend systematic ocean color, atmospheric aerosol, and cloud data records for Earth system and climate studies. To address new and emerging science questions by detecting a broader range of color wavelengths that will provide new and unprecedented detail.

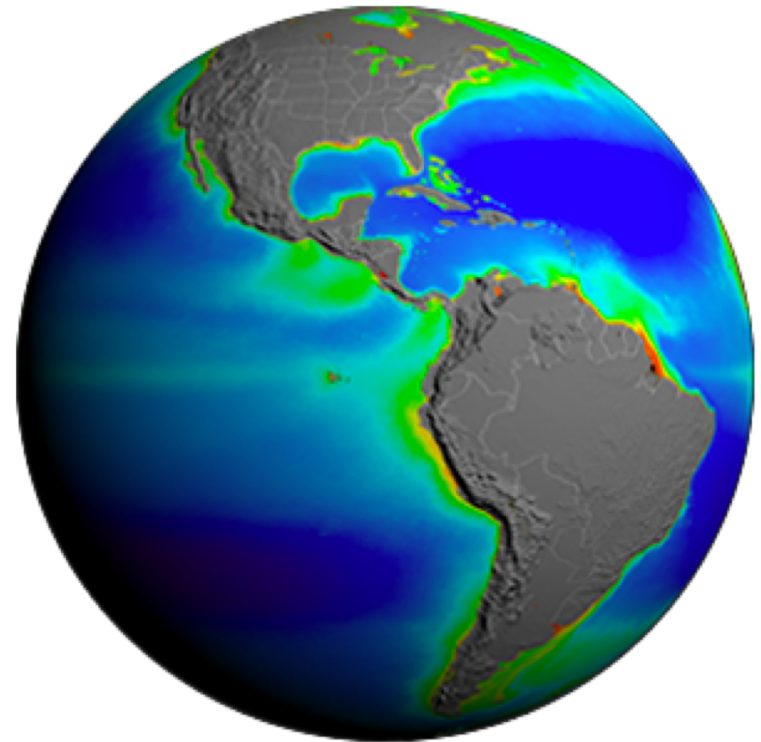

Key Mission Characteristics

- Hyperspectral ocean color instrument
- Two multi-angle polarimeters
- Launch readiness date: Fall 2022
- 675 km (419 mi) orbital altitude
- Sun-synchronous, polar orbit
- Global coverage every two days
- Managed by Goddard Space Flight Center



GPS Antenna Characterization Experiment (ACE)



Overview

- GPS L1 C/A signals from GEO are available at a ground station through a “bent-pipe” architecture
- Map side lobes by inserting advanced, weak-signal tracking GPS receivers at ground station to record observations from GEO

Data Collection & Visualization

- Trace path of GEO vehicle in antenna frame of each GPS vehicle
- Reconstruct full gain pattern after months of tracking

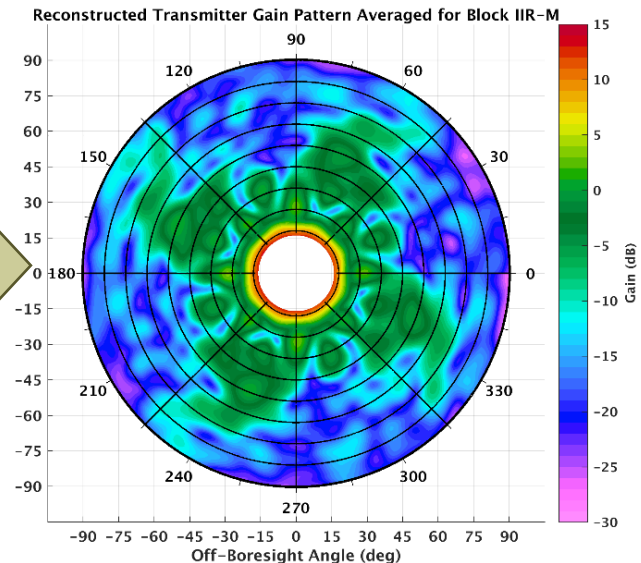
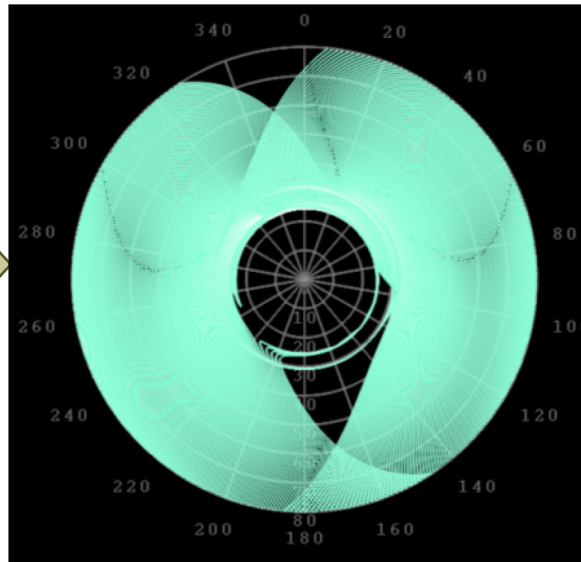
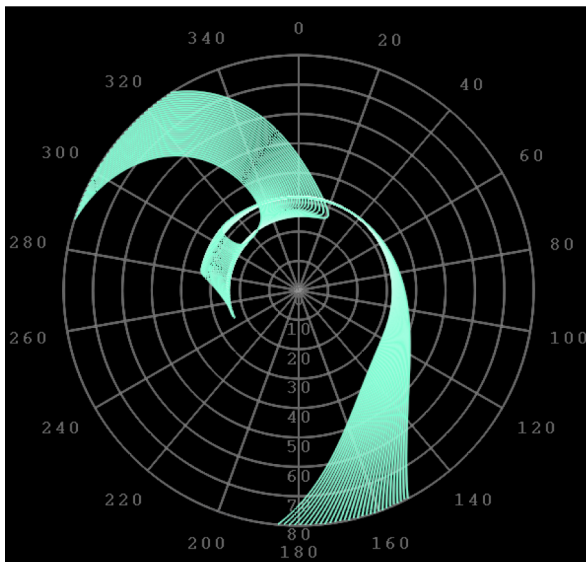
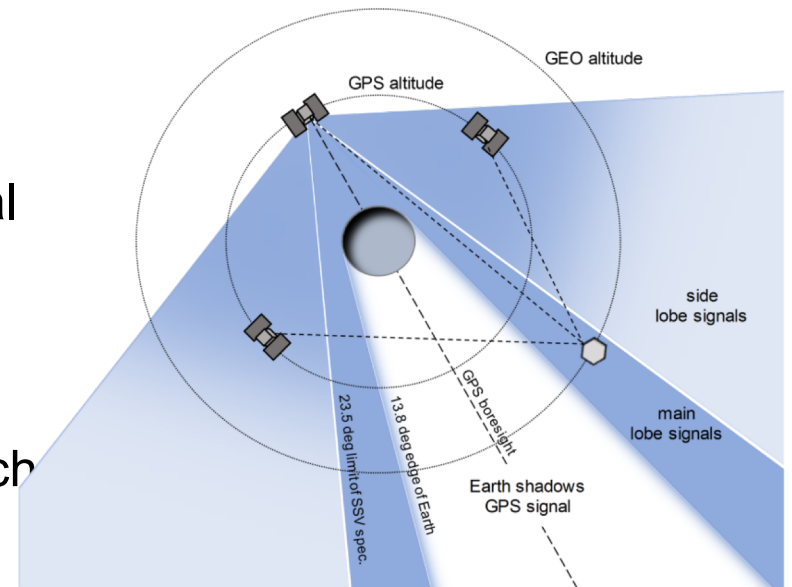



ACE Results Average Transmit Gain – Block IIR



- In-flight averaged over all SVNs in block in 1 deg x 1 deg bins
- Remarkable similarity between average flight and ground measurements
 - Note matching patterns in nulls around outer edge

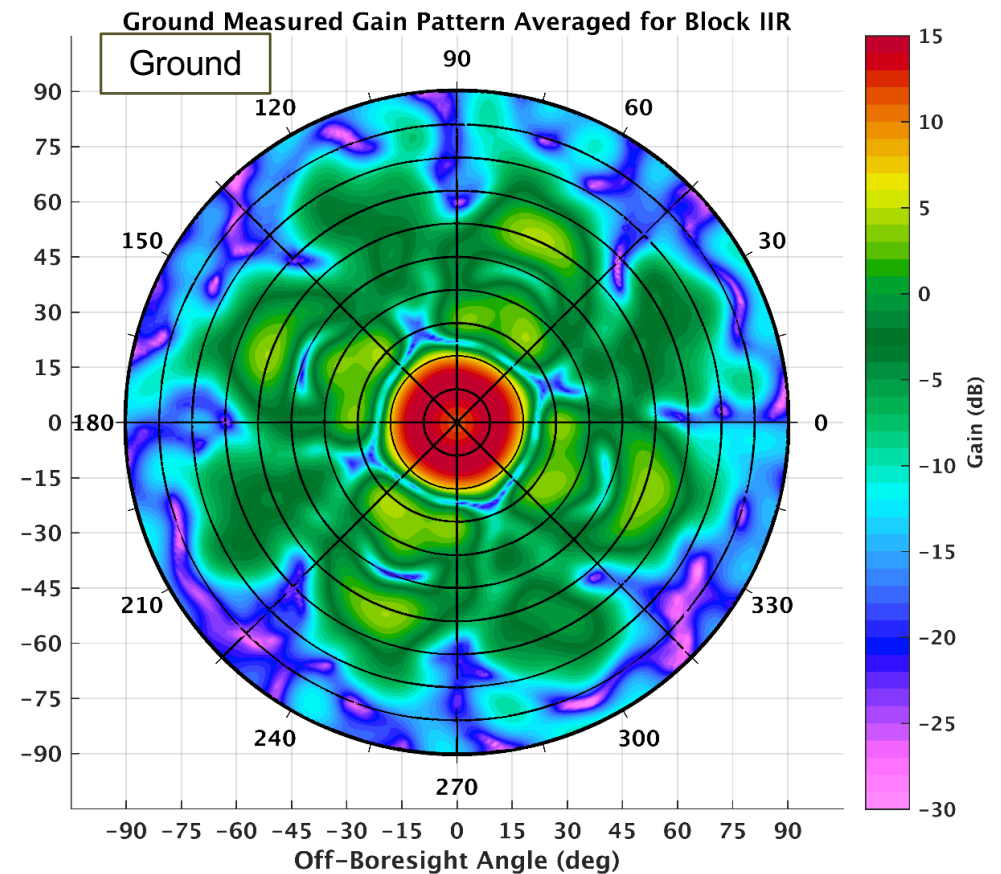
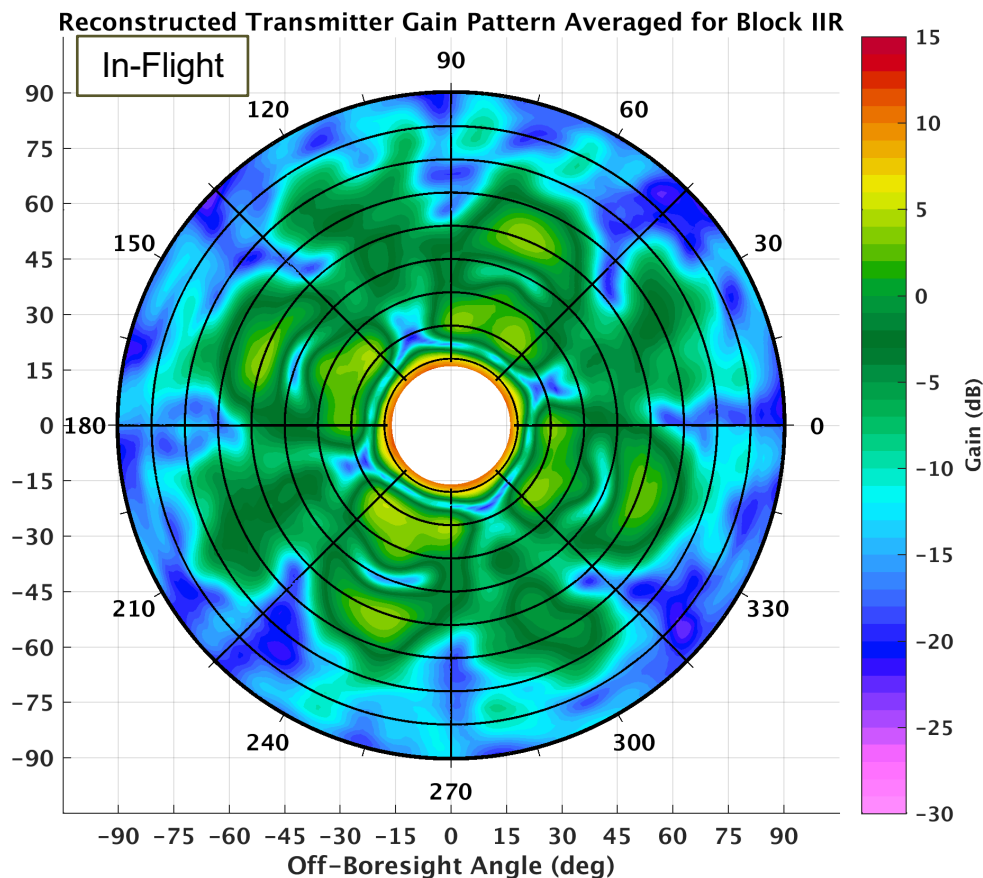



ACE Results Average Transmit Gain – Block IIA/IIF



- Averaged over all SVNs in block in 1 deg x 1 deg bins
- IIF side lobes are shifted 45 deg in azimuth from other blocks

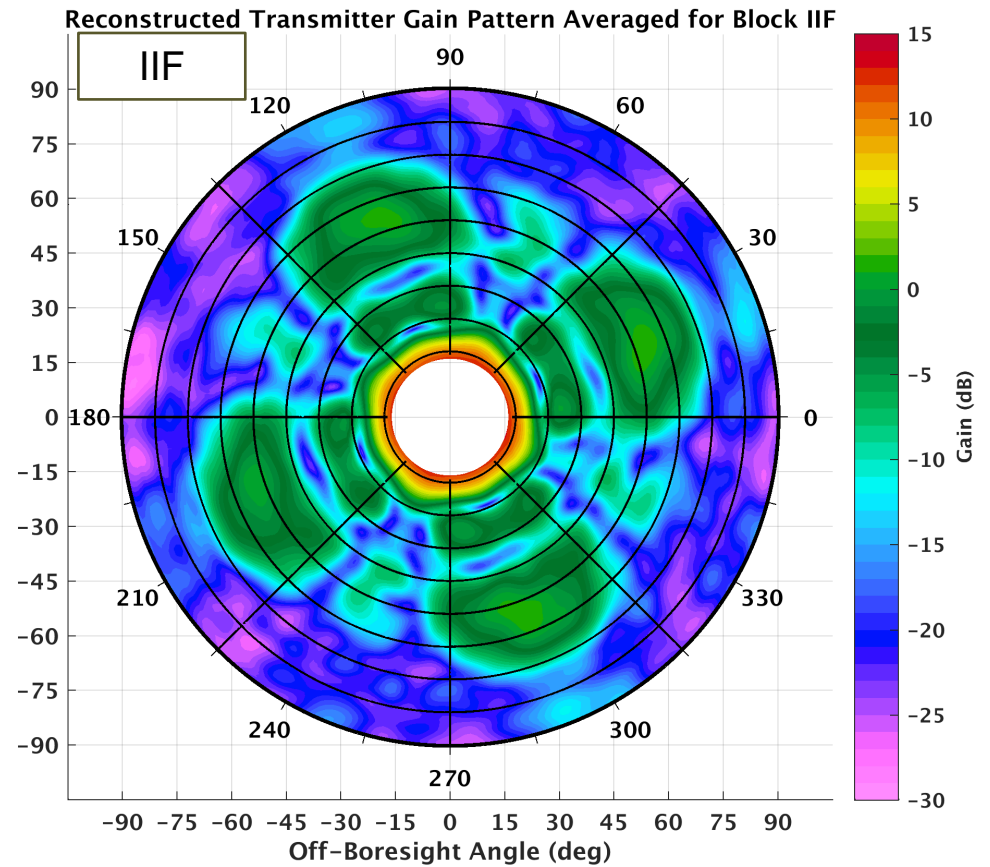
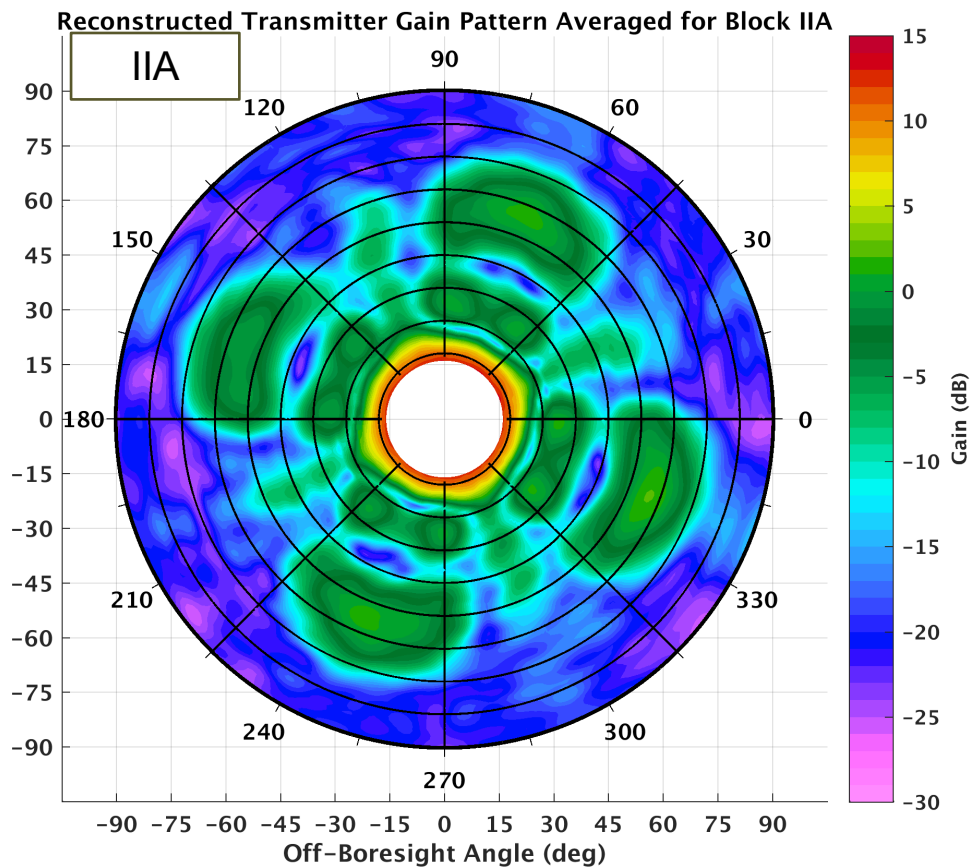



GPS ACE Conclusions



- GPS ACE architecture permits tracking of extremely weak signals over long duration
 - MGPSR produces signal measurements well into back lobes of GPS vehicles
 - 24/7 GPS telemetry provides near continuous tracking of each PRN
- First reconstruction of full GPS gain patterns from flight observations
 - Block averages of IIR, IIR-M show remarkable consistency with ground patterns
 - Demonstrates value in extensive ground testing of antenna panel
 - Characterized full gain patterns from Blocks IIA, IIF for the first time
 - Patterns permit more accurate simulations of GPS signal availability for future HEO missions
- Additional analysis of pseudorange deviations indicate usable measurements far into side lobes
- Dataset available at: <https://esc.gsfc.nasa.gov/navigation>



Recent Results: Lunar GPS



- NASA has recently published two studies looking at the feasibility of GPS navigation at lunar distances:
 - ION GNSS+ 2017: Winternitz, et al¹
 - Published MMS Phase 2 results using GPS to 25 RE
 - Projected MMS performance to lunar distance
 - AAS GN&C 2018: Ashman, et al²
 - Looked broadly at GPS visibility for different antennas and C/N0 receiver threshold values
 - Validated results vs. MMS and GOES-16 flight data
- These studies represent early GPS-only analyses that could be used as basis for WG-B in-depth analysis.

¹Winternitz, Luke B., Bamford, William A., Price, Samuel R., "New High-Altitude GPS Navigation Results from the Magnetospheric Multiscale Spacecraft and Simulations at Lunar Distances," *Proceedings of the 30th International Technical Meeting of The Satellite Division of the Institute of Navigation (ION GNSS+ 2017)*, Portland, Oregon, September 2017, pp. 1114-1126.

²Ashman, Benjamin W., Parker, Joel J. K., Bauer, Frank H., "Exploring the Limits of High Altitude GPS for Future Lunar Missions," *American Astronautical Society Guidance and Control Conference*, Breckenridge, Colorado, USA, February 2–8, 2017.

NASA's Magnetospheric MultiScale (MMS) Mission

- Discover the fundamental plasma physics process of reconnection in the Earth's magnetosphere.
- Coordinated measurements from tetrahedral formation of four spacecraft with scale sizes from 400km to 10km
- Flying in multiple highly-elliptical orbits:
 - Phase 1 1.2x12 R_E (magnetopause) Mar '14-Feb '17
 - Phase 2B 1.2x25 R_E (magnetotail) May '17-present
 - 2019: Apogee raise to 1.2x29 R_E

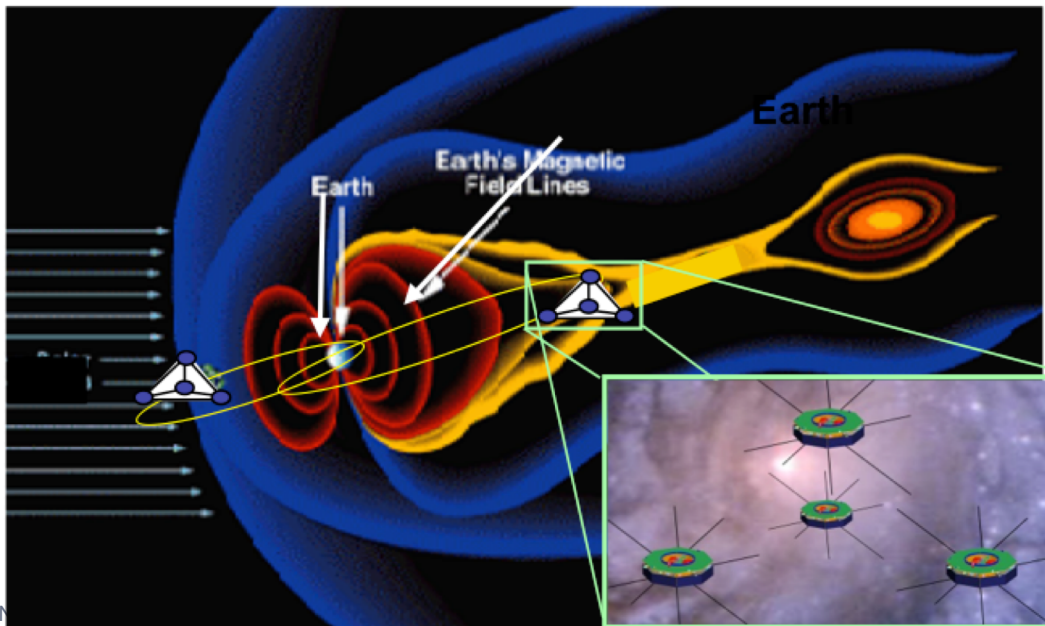



2017 MMS study: Concept Lunar mission



- Study: How will MMS receiver perform if used on a conceptual Lunar mission with 14dBi high-gain antenna?
- GPS measurements simulated & processed using NASA GEONS filter.
- Visibility similar to MMS Phase 2B, as high-gain makes up for additional path loss
 - Avg visibility: ~3 SVs; C/N0 peaks > 40dB-Hz (main lobes) or > 30 dB-Hz (side lobes)
- Range/clock-bias errors dominate – order of 1-2 km; lateral errors 100-200 m
 - With atomic clock, or, e.g., periodic 2-way range/Doppler, could reduce range errors to meas. noise level

Top: Signals tracked and radial dist to Earth (red) and Moon (cyan); Bottom: C/N₀

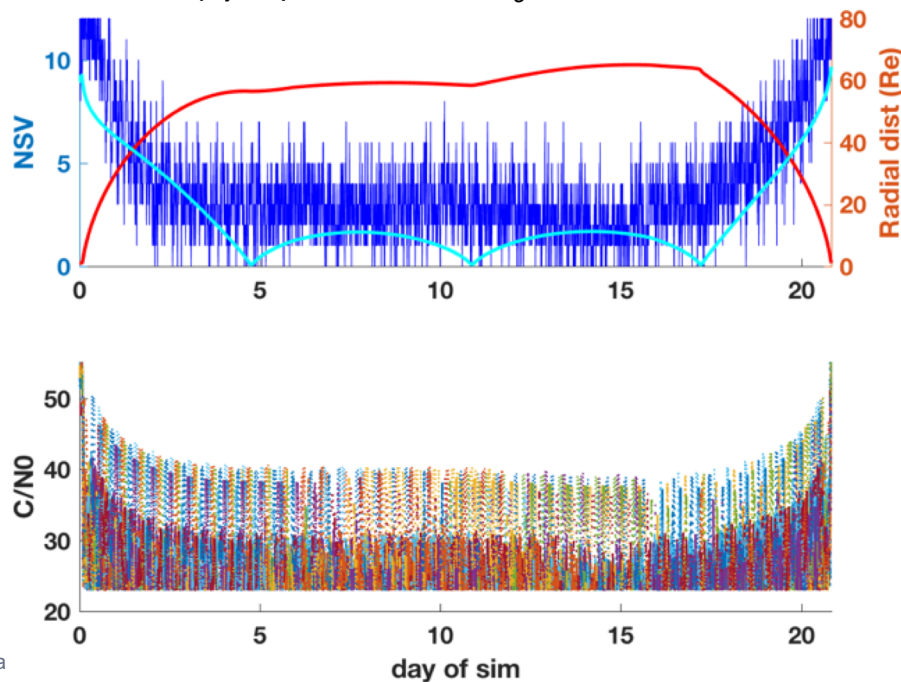

Filter position formal (3σ) and actual errors

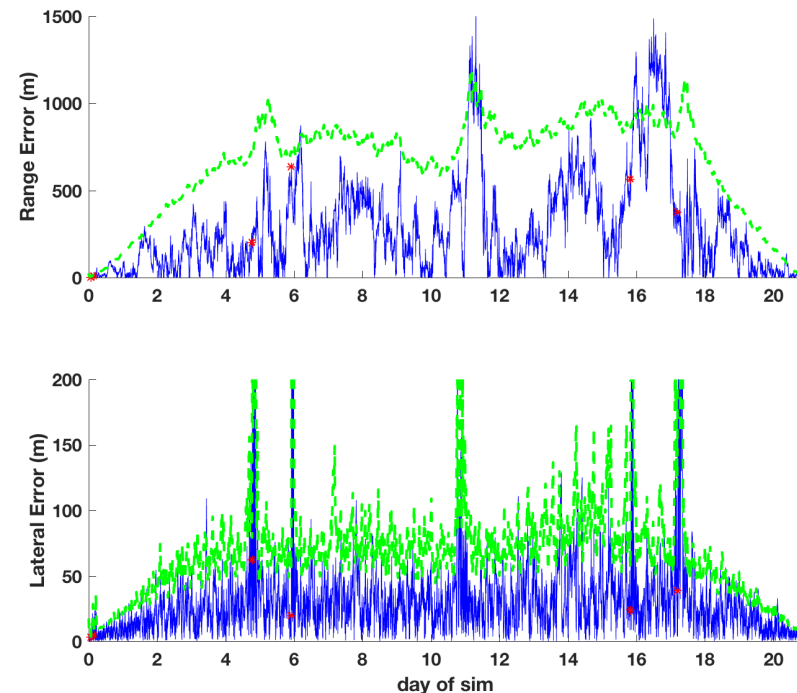



2018 Lunar GPS Visibility Study



- GPS constellation modeled as accurately as possible, including sidelobe signals; validated with GOES-16 and MMS flight data
- Calibrated models applied to outbound lunar near-rectilinear halo orbit (NRHO) GPS receiver reception with 22 dB-Hz acq/trk threshold

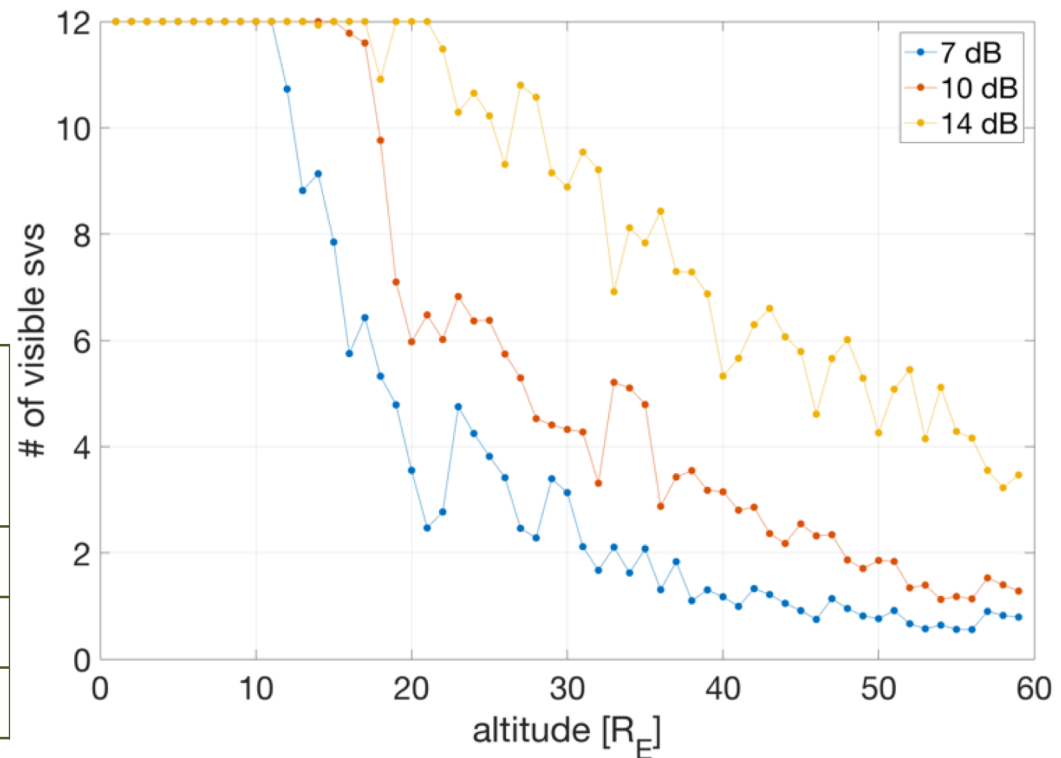

Peak Antenna Gain	1+ Vis.	4+ Vis.	Maximum Outage
7 dB	63%	8%	140 min
10 dB	82%	17%	84 min
14 dB	99 %	65%	11 min

- A modest amount of additional antenna gain or receiver sensitivity increases coverage significantly



2018 Lunar GPS Visibility Study



Conclusions

- These results show useful onboard GPS navigation at lunar distances is achievable *now* using *currently-available* signals and *flight-proven* receiver technology.
- A modest increase in gain or receiver sensitivity increases visibility significantly.
- Future work must extend these specific studies to full navigation analysis of cis-lunar spacecraft, including effects of DOP, and utilizing the *full capability* of multi-GNSS signals.
- ICG WG-B is a natural forum for these discussions and analyses, in keeping with the ICG-12 recommendation for analysis for cis-lunar missions and beyond.

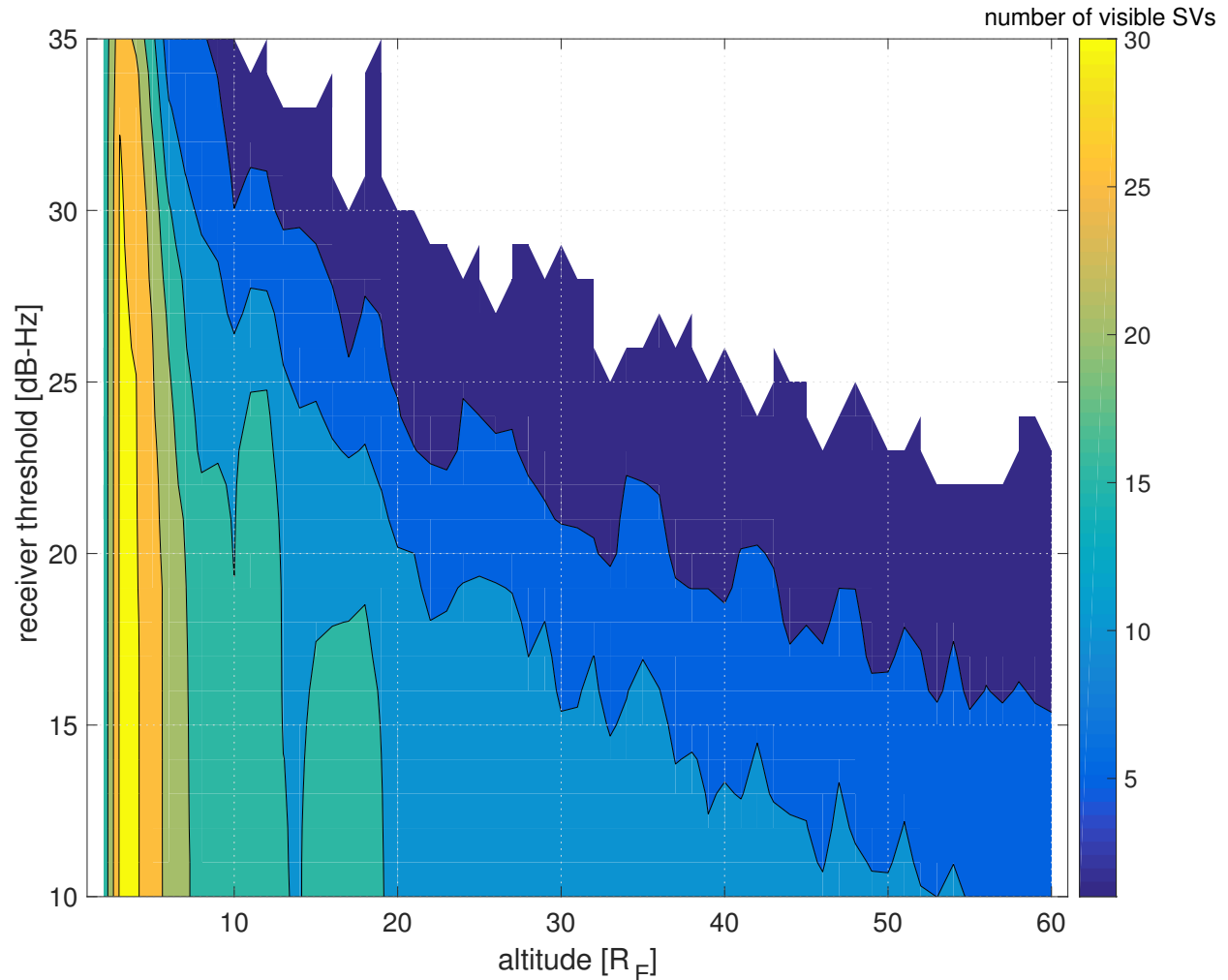

Number of satellites visible by altitude and receiver threshold



Potential Future Application: Lunar Orbital Platform—Gateway



- NASA Exploration Campaign: Next step is deployment and operations of US-led Lunar Orbital Platform—Gateway (previously known as Deep Space Gateway)
- Step-off point for human cislunar operations, lunar surface access, missions to Mars
- Features include:
 - Power and propulsion element (PPE) – targeted for 2022
 - Human habitation capability
 - Docking/rendezvous capability
 - Extended uncrewed operations (not continuously crewed)
 - Lunar near-rectilinear halo orbit (NRHO)
- Gateway conceptual studies are continuing with ISS partners
 - Requirements to be baselined in 2018
 - To be followed by Broad Agency Announcement for partnerships
- Gateway represents a potential application for on-board GNSS navigation
- NASA will continue providing updates to WG-B as plans develop.

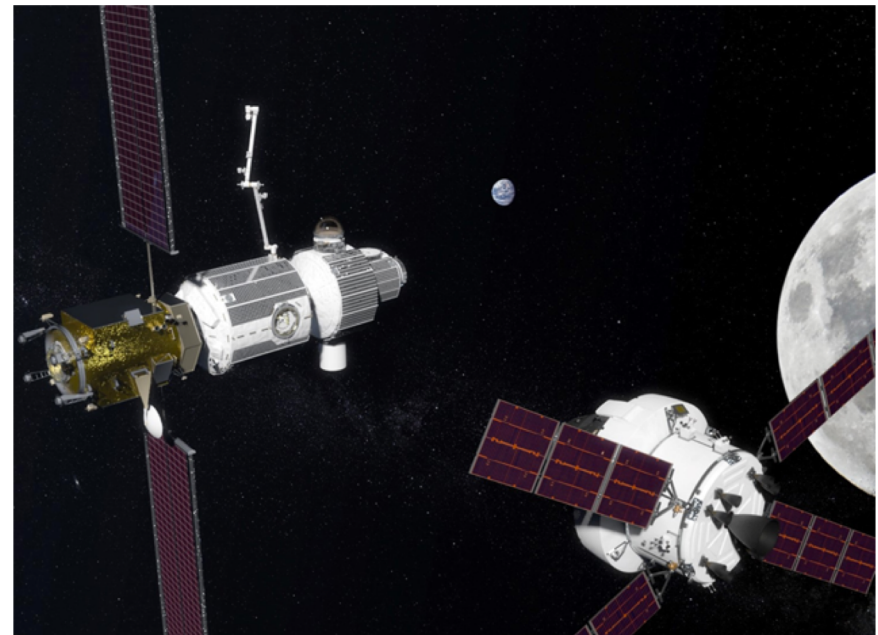
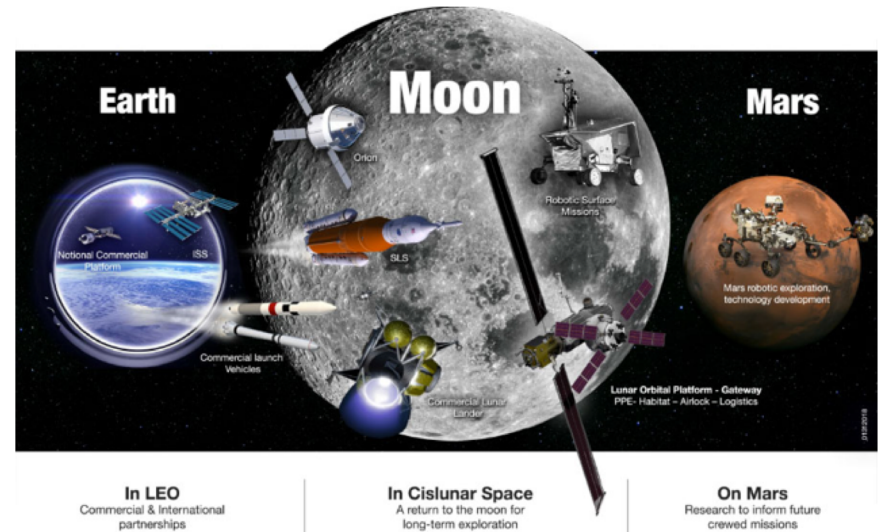

<https://www.nasa.gov/feature/nasa-s-lunar-outpost-will-extend-human-presence-in-deep-space>



Potential Future Application: Lunar Orbital Platform—Gateway



GATEWAY A spaceport for human and robotic exploration to the Moon and beyond

- HUMAN ACCESS TO & FROM LUNAR SURFACE**
Astronaut support and teleoperations of surface assets.
- U.S. AND INTERNATIONAL CARGO RESUPPLY**
Expanding the space economy with supplies delivered aboard partner ships that also provide interim spacecraft volume for additional utilization.
- INTERNATIONAL CREW**
International crew expeditions for up to 30 days as early as 2024. Longer expeditions as new elements are delivered to the Gateway.
- SCIENCE AND TECH DEMOS**
Support payloads inside, affixed outside, free-flying nearby, or on the lunar surface. Experiments and investigations continue operating autonomously when crew is not present.
- SAMPLE RETURN**
Pristine Moon or Mars samples robotically delivered to the Gateway for safe processing and return to Earth.
- COMMUNICATIONS RELAY**
Data transfer for surface and orbital robotic missions and high-rate communications to and from Earth.
- SIX DAYS TO ORBIT THE MOON**
The orbit keeps the crew in constant communication with Earth and out of the Moon's shadow.
- A HUB FOR FARTHER DESTINATIONS**
From this orbit, vehicles can embark to multiple destinations: The Moon, Mars and beyond.

GATEWAY SPECS

- 4 Crew Members
- 30-90 Day Crew Missions
- 125 m³ Pressurized Volume
- Up to 75mt with Orion docked

ACCESS

- 384,000 km from Earth
- Accessible via NASA's SLS as well as international and commercial ships.

20180813

Global Exploration Roadmap

- The GER is a human space exploration roadmap developed by 14 space agencies participating in the International Space Exploration Coordination Group (ISECG)

- First released in 2011. Updated in 2013 and 2018.

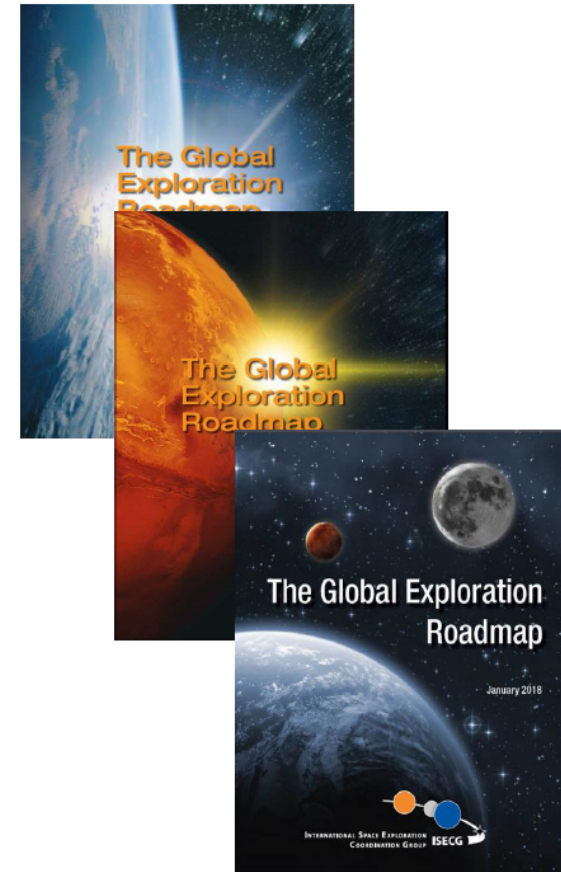

- The non-binding strategic document reflects consensus on expanding human presence into the Solar System, including
 - Sustainability Principles, spaceflight benefits to society
 - Importance of ISS and LEO
 - The Moon: Lunar vicinity and Lunar surface
 - Mars: The Driving Horizon Goal

www.globalspaceexploration.org
www.nasa.gov/isecg

The Global Exploration Roadmap

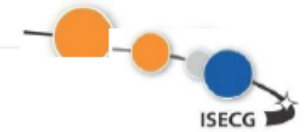

2020

2030

2040

ON TO MARS

MARS SURFACE

Robotic Mars Sample Return

MARS ORBIT



Goal of Humans on the Martian Surface



Mars Transportation Capabilities

Mars Orbital Mission

TO THE MOON

LUNAR SURFACE

Robotic Resource Prospecting Missions

LUNAR ORBIT



IN LEO

EARTH ORBIT



Deep Space Gateway

Gateway Moon and Mars Mission Support Operations



Human Lunar Surface Exploration

Orion and SLS



Commercial Transportation Systems



Russian Crew Transportation System

International Space Station

China Space Station

Future Platforms

GNSS Navigation Domain

10+ international lunar exploration missions planned for next 10 years; many opportunities for demonstration of lunar GNSS capabilities

Global Exploration Roadmap

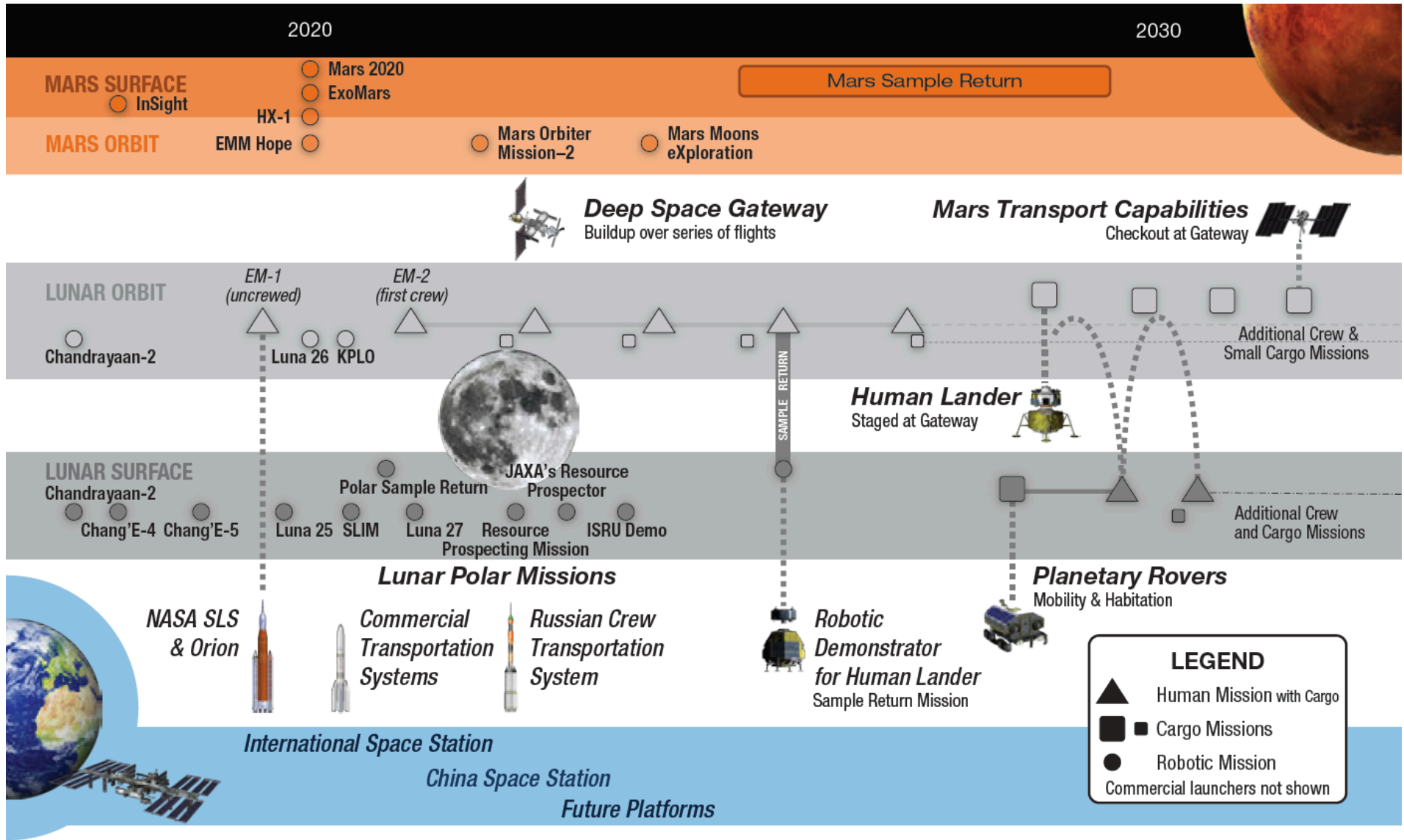

NASA-USAF SSV Collaboration

- **Oct 13 2017: Joint NASA-USAF Memorandum of Understanding (MOU) signed**

MOU addresses civil Space Service Volume (SSV) requirements

Scope relevant to GPS IIF acquisition process

- » Civil space early insight into Block IIF design relevant to SSV performance
- » Access to Block IIF, III, and IIF technical data

- **MOU results to-date:**

US civil space rep. from NASA supported GPS IIF source selection team as SSV technical expert

Built positive, collaborative relationships with IIF acquisition team; provided civil space insight continuing through design and production

NASA received released GPS IIF antenna pattern measurements per MOU and to support NASA Space Launch System need

*MOU supports SSV signal continuity goals
for future space users*



Automatic Flight Termination System (AFTS)



- Independent, self-contained subsystem mounted onboard a launch vehicle
- Flight termination / destruct decisions made autonomously via redundant Global Positioning System (GPS)/Inertial Measurement Unit (IMU) sensors
- Primary FTS for unmanned Range Safety Operations and being considered as Primary FTS for human space flight (Commercial Crew and SLS)
- Advantages:
 - Reduced cost—decreased need for ground-based assets
 - Global coverage (vehicle doesn't have to be launched from a range)
 - Increased launch responsiveness
 - Boundary limits increase due to 3-5 second gain from not having Mission Flight Control Officer (MFCO)
 - Support multiple vehicles simultaneously (such as flyback boosters)



April 2006: WSMR
Sounding Rocket

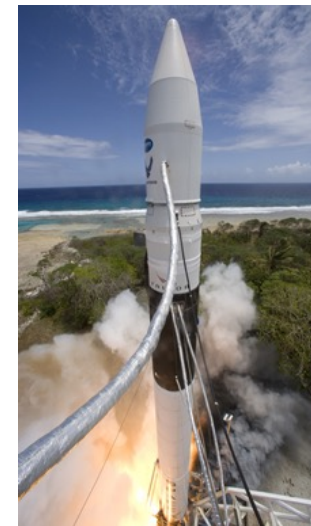

Mar 2007:
SpaceX F1

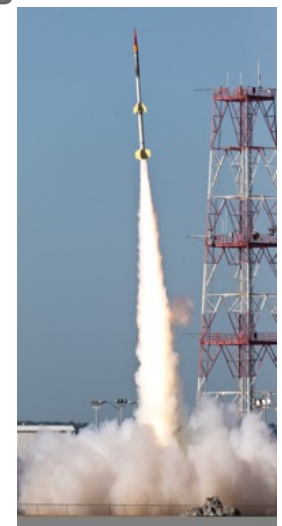

Sept 2010: WFF
Sounding Rocket

Enabling low cost, responsive, reliable access to space for all users

GALileo Receiver for the ISS (GARISS)

- **Objectives:**

- Demonstrate combined GPS/Galileo (L5/E5a) navigation receiver on-orbit with upload of Software Radio waveform
- Add waveform to Space Telecommunications Radio Systems (STRS) waveform repository

- **Approach/Benefits:**

- Adapt existing Galileo PNT code to Software Defined Radio (SDR) inside ScAN Test Bed (STB) onboard International Space Station (ISS)
- Demonstrate operations, conduct PNT experiments on ISS
- Flexibility of SDR technology, STRS operating environment

- **Timeline:**

- Initial discussions at International meetings (mid-2014)
- Project formulation/export license (mid-2016)
- Waveform design and development (late 2016-mid 2017)
- Qualification and test the Galileo/GPS waveform (mid 2017-late 2017)

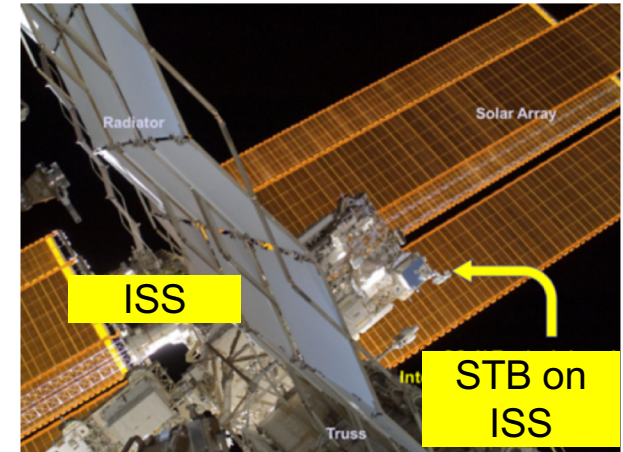

GARISS waveform development is an element of NASA/ESA cooperation involving multiple centers, Qascom

On-orbit waveform integration and testing

- Moved integration and testing to on-orbit operations April 2018
- Successful on-orbit acquisition, track and PVT solution
- Full function for GPS and Galileo processing established at qualification review (May 2018) :
 - Acquisition and Time to First Fix (TTFF) requirements are met for Galileo and for combined GPS/Galileo
 - GPS-only on-orbit PVT availability > 20%
 - Galileo -only on-orbit PVT availability > 40%
- **Achieved Combined Galileo/GPS PVT availability greater than 90%**
- **~64m RMS positional error (3D)**
- First-ever on-orbit direct acquisition of L5/E5a (no L1 aiding)

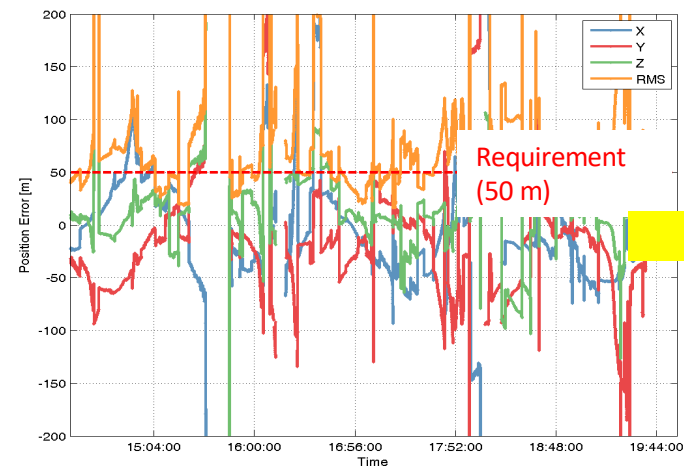
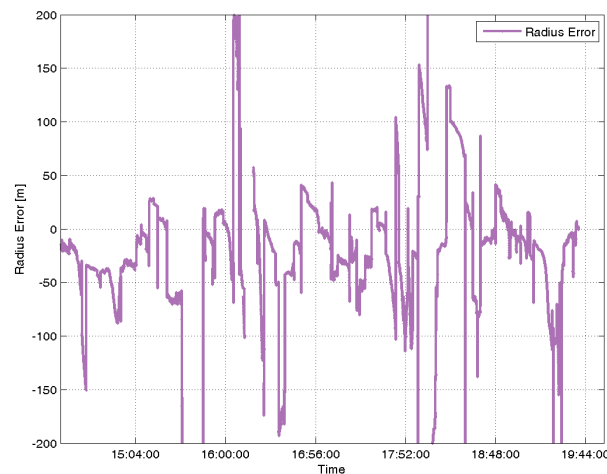



Real-Time Monitoring of GPS, GLONASS, BeiDou, Galileo, and QZSS by the GDGPS System



28 BDS in view (61 sites reporting)

Page generated on Sat Oct 20 22:01:21 2018 (UTC)
Data Epoch: 21 seconds prior to page generation, Sat Oct 20 22:01:00 2018 (UTC)

BDS Integrity Monitor: Table sorted by SVN
without auto-update (Go to version with 30-sec auto-update)

SVN	PRN	Orbit	Block	Performance metrics				Orbit/Clock error metrics				Link Statistics					AOD	Health	SVN	
				URE	FORD	URA	URE/URA	UREE	CLK	RSS	RAC	SIGMA	Total	Good	Bad	Missing				BCE
101	1	GEO-2	(?)	8.08	9.57	4.00	2.02	1.24	-9.30	1.99	plot	0.00	20	20	0	0	11	1.0	0	101
103	3	GEO-2	(?)	-	-	-	-	-	-	-	plot	-	21	19	0	2	18	1.0	0	103
104	4	GEO-2	(?)	4.72	1.57	4.00	1.18	1.29	-5.76	4.97	plot	0.00	20	18	0	2	10	1.0	0	104
105	5	GEO-2	(?)	9.71	3.15	4.00	2.43	0.92	-10.39	4.40	plot	0.00	27	23	0	4	19	1.0	0	105
106	2	GEO-2	(?)	4.53	2.42	4.00	1.13	0.86	-4.34	6.20	plot	0.00	24	22	0	2	18	1.0	0	106
201	6	IGSO-2	(?)	0.74	2.41	4.00	0.19	0.78	0.05	3.03	plot	0.00	22	19	0	3	-1	4.0	0	201
202	7	IGSO-2	(?)	5.22	5.32	4.00	1.31	0.59	-5.12	4.19	plot	0.00	21	20	0	1	-1	1.0	0	202
203	8	IGSO-2	(?)	5.21	4.43	4.00	1.30	0.60	-4.65	1.57	plot	0.00	24	20	0	4	-1	1.0	0	203
204	9	IGSO-2	(?)	1.78	2.41	4.00	0.45	0.88	2.60	2.11	plot	0.00	26	24	0	2	-1	3.0	0	204
205	10	IGSO-2	(?)	0.61	2.42	4.00	0.15	0.65	0.06	3.24	plot	0.00	19	16	0	3	-1	1.0	0	205

- Real-time (6 sec latency) orbit determination operations
- Additional hourly precise orbit determination operations
- Real time environmental monitoring: earthquakes, space weather, tsunamis

C1C-C1W: 15 day fits minus their most recent value

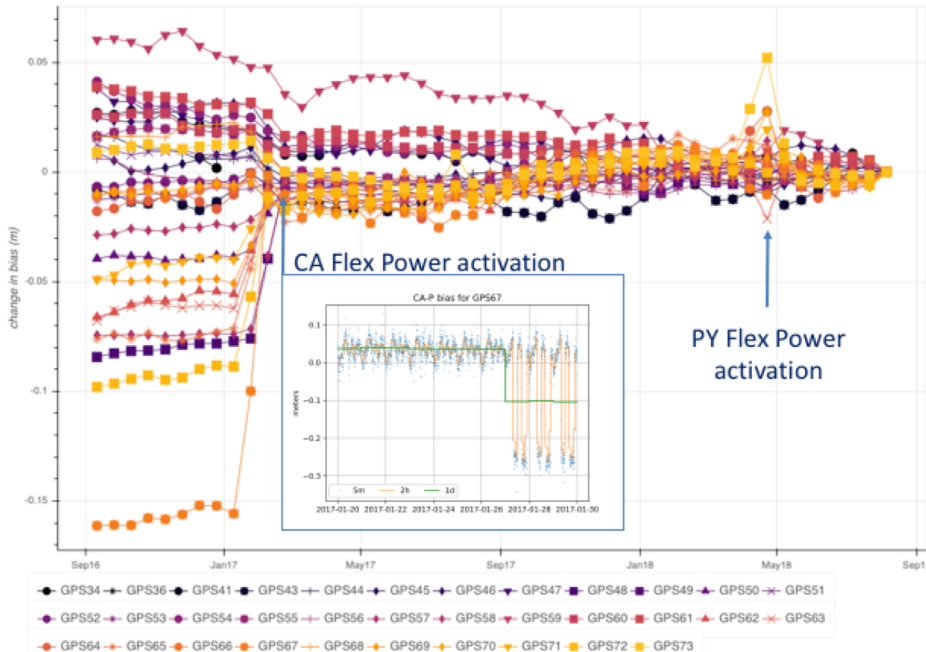

- Differential Code Bias Monitoring for all GNSS signals at high rate (especially needed to monitor GPS Flex Power)



Cion – NASA’s new Software-Defined GNSS Radio Science Instruments for Cubesats



Low cost, low power, high performance space GNSS receiver for POD and radio occultations (RO)

- Designed by JPL and built by Tyvak for initial use on GeoOptics’ CICERO RO Constellation
- Based on the PicoZed off the shelf OEM computer and JPL’s TriG GPS receiver design
- A NASA Class D version of this design has recently been completed

Key Cion Features:

- 3 antenna inputs with 4 down converters each
- 1.2 GHz Dual Core Arm processor
- 30cm X 10cm X 6cm
- 1 kg
- ~10 watts at 12 VDC
- Can be coupled with an external receiver to increase number of channels available for radio science

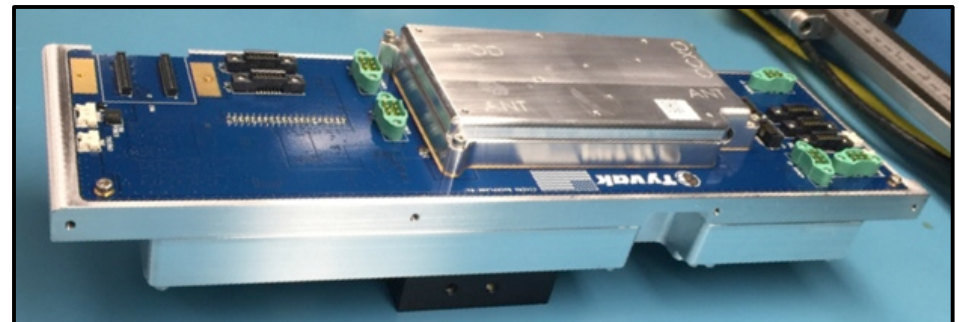

Tyvak-Built Cion Receiver

Successful operations on CICERO in orbit since March 2018, providing GPS and GLONASS radio occultation data

- Coupled with a Novatel GPS+GLONASS POD receiver
- Launch of additional CICERO satellites anticipated in 2018

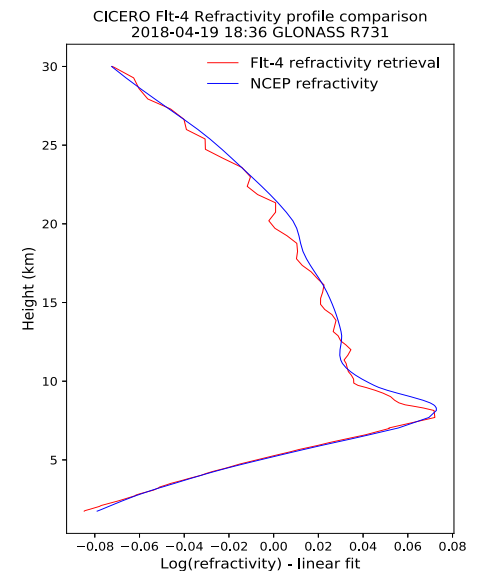



Summary



- NASA is engaged in numerous space-based GNSS initiatives that are bearing great fruit for science and future mission development
- The NASA civil GNSS space user fleet is growing and expanding into new regimes
 - GRACE retired after 15 years of groundbreaking science
 - Space Launch System (SLS) has five upcoming cislunar exploration flights with GPS onboard
 - Restore-L and PACE will add to NASA's extensive use of GPS in LEO
- NASA studies on cislunar use of GPS show high level of potential performance in lunar orbit with modest investments in receiver system capabilities.
 - The int'l Gateway project and the Global Exploration Roadmap provide numerous opportunities for in-depth study and inflight demonstrations.
- NASA's GPS Antenna Characterization Experiment (ACE) has gathered and published the most extensive dataset on GPS antenna patterns for space users to-date, enabling a new series of high-fidelity mission simulations in the SSV.
- NASA technology developments have achieved numerous milestones:
 - Automatic Flight Termination System (AFTS) is providing operational GPS-based range safety since 2017
 - GARISS achieved the first direct acquisition of L5/E5a in space, and is exceeding its performance requirements in initial flight tests
 - JPL GDGPS system is providing real-time monitoring of GPS, GLONASS, Galileo, BDS, QZSS
 - New JPL Cion GNSS receiver for CubeSats is operational on-orbit
- We encourage GNSS providers to report on their activities to support the global space user community and enhance the utility of interoperable GNSS in space

GPS Signal Structure

Outline

- I. GNSS signals
- II. GNSS receivers
- III. Measurements
- IV. Time reference, orbits, coordinate frames
- V. Navigation solution



Block IIF GPS Satellite [2]

GPS signal structure

- What is required of a radionavigation signal?
 1. Propagation delay between transmitter and receiver can be measured
 2. Transmitters can be distinguished, enabling geometric diversity
 3. Modulation allowing the signal to propagate through space
- For any signal $p(t)$ combined with Additive White Gaussian Noise (AWGN) $n(t)$,

$$p(t) + n(t)$$

correlation with a copy of $p(t)$ maximizes the output signal to noise ratio (SNR) (i.e., optimal estimator in the Maximum Likelihood sense), so $p(t)$ is designed to have a correlation shape that satisfies signal requirements 1 and 2

- Delay estimation

Consider a known, continuous-time signal $p(t)$ generated at the transmitter that arrives at the receiver with some delay τ :

$$p(t - \tau)$$

In order to estimate τ , a local replica of $p(t)$ is formed at the receiver with test delay $\tilde{\tau}$.

The delay estimate, $\hat{\tau}$, is the test delay that maximizes the average (over T_I) of the inner product:

$$\hat{\tau} = \arg \max_{\tilde{\tau}} \frac{1}{T_I} \int_{t-T_I}^t p(\alpha - \tilde{\tau}) p(\alpha - \tau) d\alpha$$

GPS signal structure: code

- Autocorrelation in terms of alignment error, $\epsilon = \tilde{\tau} - \tau$:

$$R(\epsilon) = \frac{1}{T_I} \int_{t-T_I}^t p(\alpha - \tilde{\tau})p(\alpha - \tau)d\alpha$$

The ideal autocorrelation function would be

$$R(\epsilon) = \begin{cases} 1 & \text{for } \epsilon = 0 \\ 0 & \text{elsewhere} \end{cases}$$

- Multiple signals are required in order to form a position estimate, however. The trilateration problem relies on geometric diversity. One means of distinguishing transmitters is to minimize the cross correlation of signals from different transmitters:

$$R_x(\tau) = \frac{1}{T_I} \int_{t-T_I}^t p^i(\alpha)p^j(\alpha - \tau)d\alpha \qquad R_x(\epsilon) = 0 \quad \forall \epsilon$$

- These auto- and cross-correlation properties could be achieved with infinitely long random sequences of +1 and -1, known at the transmitter and receiver, and unique to each transmitter

GPS signal structure: code

- This is accomplished using **Pseudorandom Noise (PRN) codes**

Must be deterministic and finite for practical implementation, but sufficiently long and noise-like to approximate the desired autocorrelation and cross-correlation properties

- GPS Coarse Acquisition Code (C/A code) solution: Gold codes (modulo-2 sum of two linear feedback shift registers)

Periodic sequence of $\{+1, -1\}$ pulses called chips, unique to each GPS satellite, length 1023 with period of 1 ms (i.e., $f_{\text{chip}} = 1.023 \text{ MHz}$)

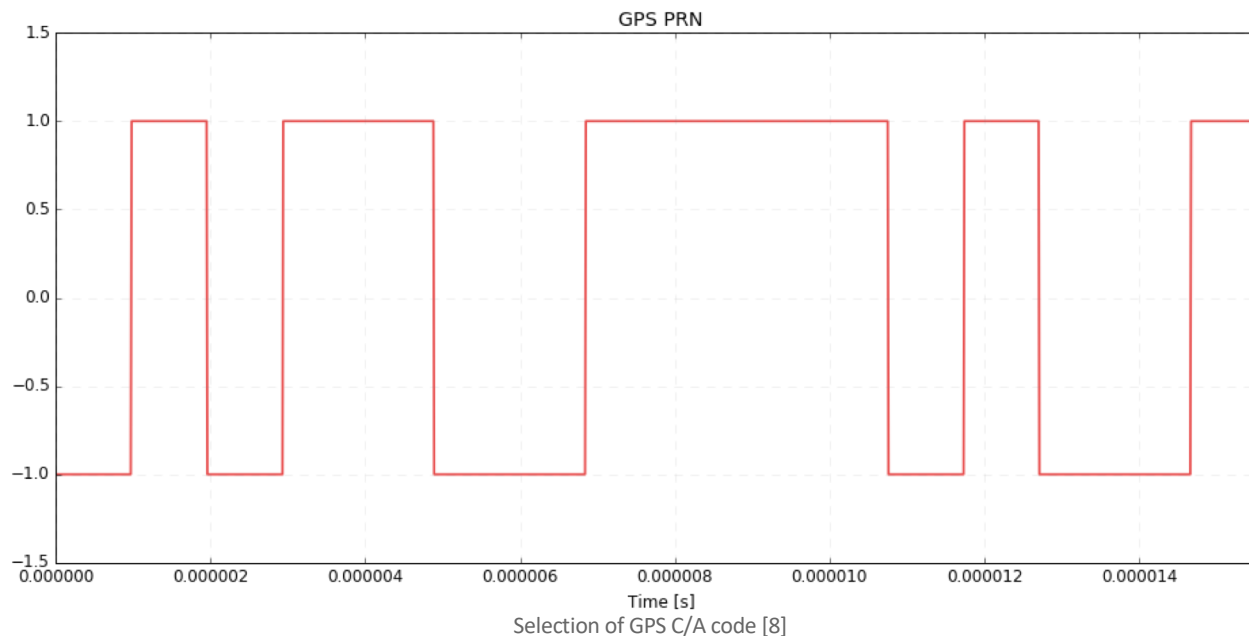

GPS signal structure: carrier

- Third navigation signal requirement: modulation allowing the signal to propagate through space

$$p(t) \cos(2\pi f_{carr}t)$$

- Radio frequencies used for satellite navigation—must penetrate atmosphere
- Apparent frequency at the receiver is Doppler shifted due to the relative motion of the transmitter and receiver

$$p(t - \tau(t)) \cos(2\pi f_{carr}(t - \tau(t)))$$

$$p(t - \tau(t)) \cos(2\pi(f_{carr} + f_D)t - \theta(t_0))$$

where $\tau(t) = \dot{\tau}t + \tau(t_0)$ and $f_D = -\dot{\tau} = -\dot{r}(t)f_{carr}/c$

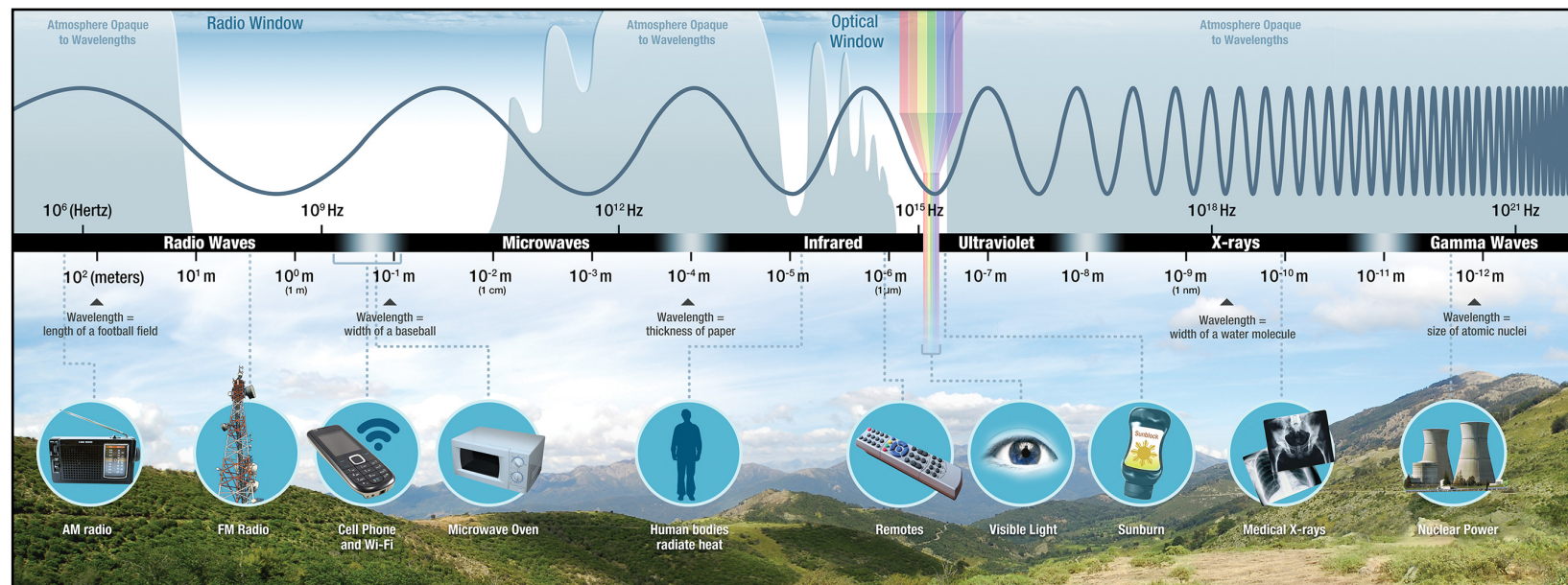

EM spectrum [9]

GNSS carriers

- A variety of carrier frequencies are used by GNSS providers

Color code: Blue—open signals Red—restricted or encrypted signals

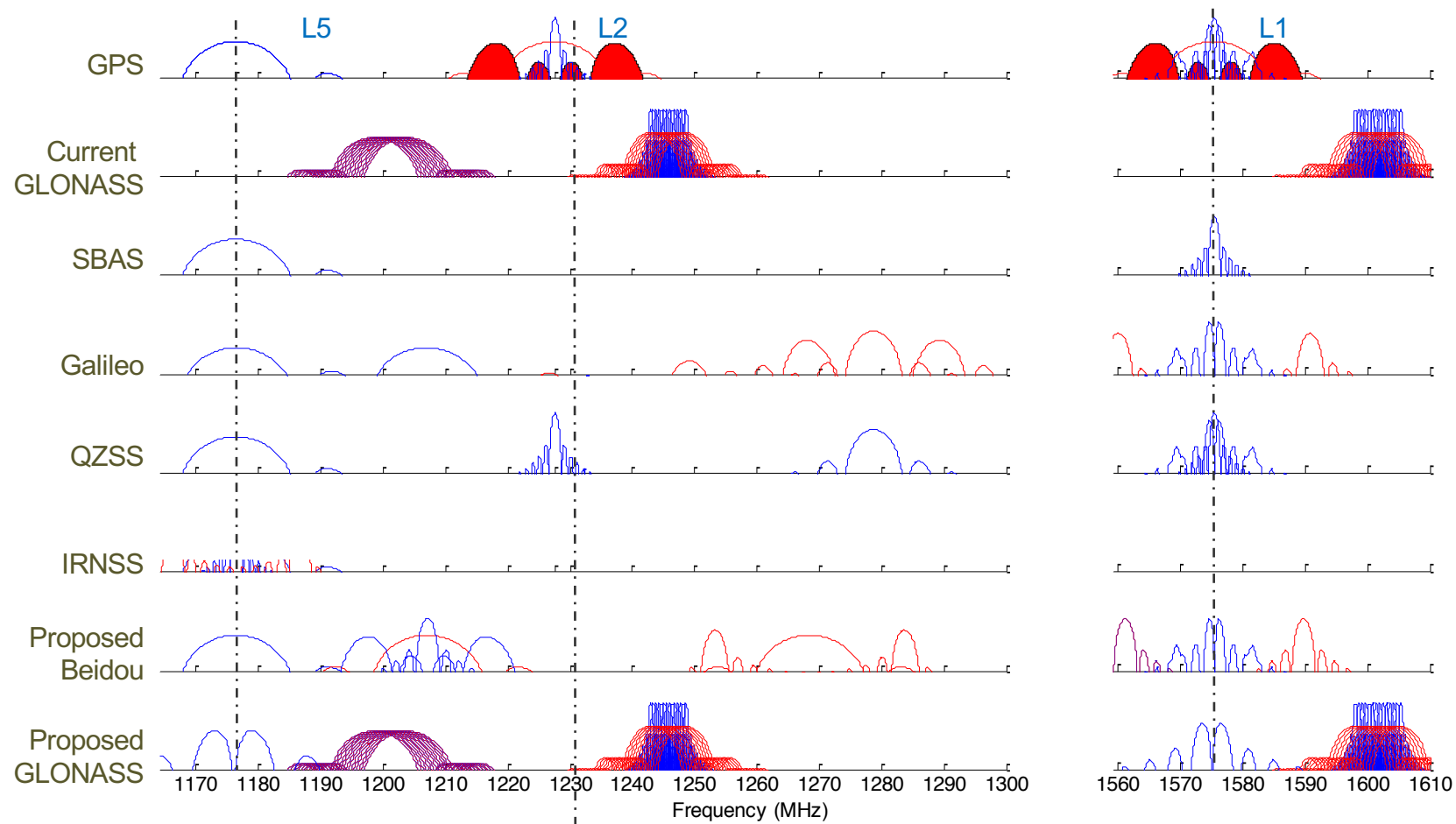

- GPS L1 ($f_{L1} = 1.57542$ GHz) will be used as an example in this presentation

GPS signal structure (continued)

- Finally, signal is also modulated with 12.5 minute navigation message, a 50 bps binary sequence containing time tags, GPS satellite ephemerides (i.e., transmitter locations), etc.
- Time domain signal:

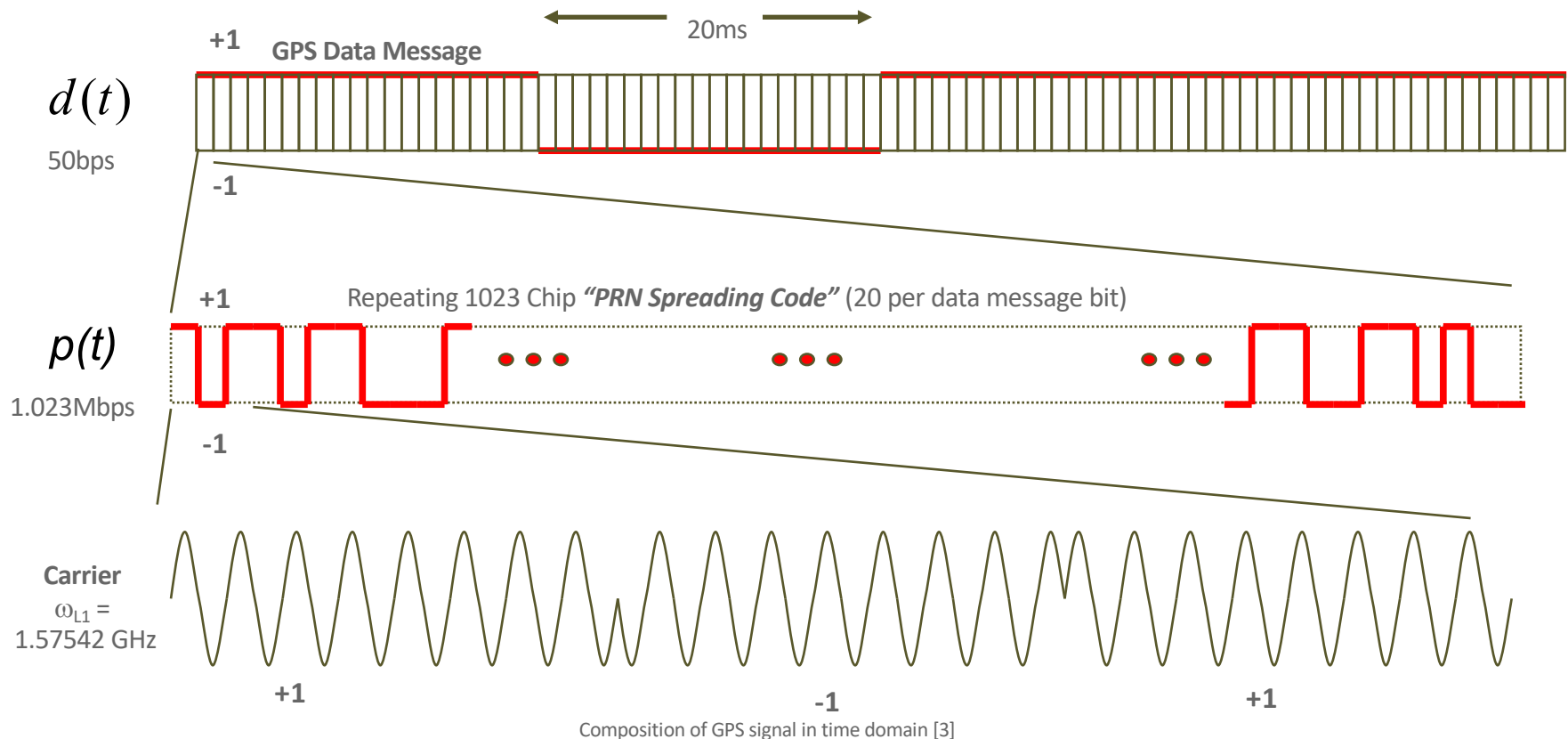

- Received L1 frequency signal from the i -th satellite

$$y^i(t) = \sqrt{2P_R} d^i(t - \tau^i(t)) p^i(t - \tau^i(t)) \cos(2\pi(f_{L1} + f_D^i)t + \theta^i(t_0)) + v^i(t)$$

GPS signal structure (continued)

- Received L1 signal from the i -th satellite

$$y^i(t) = \sqrt{2P_R} d^i(t - \tau^i(t)) p^i(t - \tau^i(t)) \cos(2\pi(f_{L1} + f_D^i)t + \theta^i(t_0)) + v^i(t)$$

- Frequency domain signal:

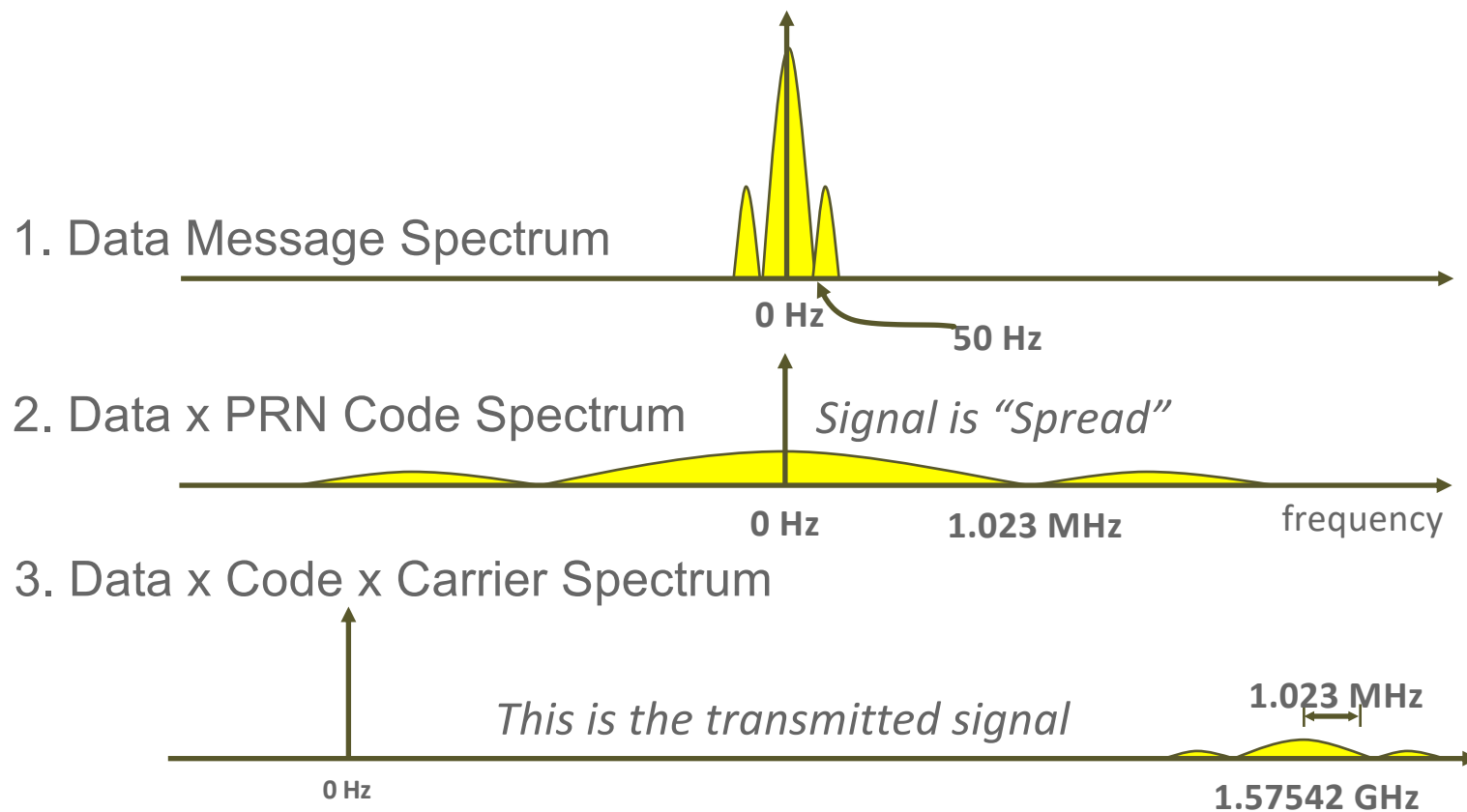

Composition of GPS signal in frequency domain [3]

GNSS receivers

- Receiver has three main tasks:
 - Acquisition:** Determine which satellites are visible and estimate the propagation delay and Doppler associated with each
 - Tracking:** Refine the delay and Doppler estimates and track these features as they change over time
 - Navigation:** Use measurements from all visible signals to estimate the receiver's position and velocity
- First the radio frequency signal is downconverted to an intermediate frequency (IF) for processing

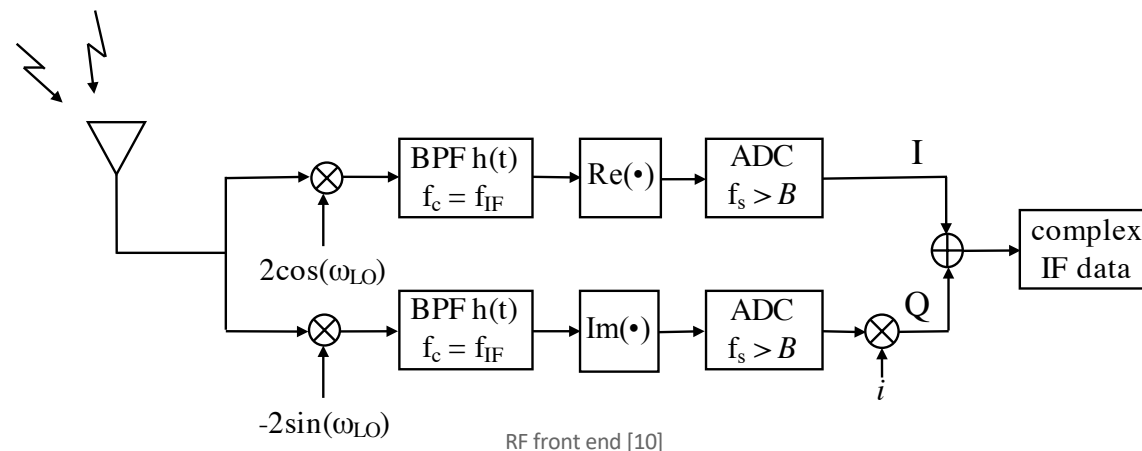

GNSS receivers: acquisition

- Acquisition seeks to determine whether a particular satellite is visible (via its unique PRN) and estimate its delay (modulo one code period, 1 ms) and Doppler
- Correlation of an incoming signal with a local replica, mismatched in frequency and delay, forms what is known as an asymmetric ambiguity function:

$$\chi(\tau, f_D) = \int_{t-T_I}^t p(\alpha)p^*(\alpha - \tau)e^{i2\pi\Delta f_D\alpha} d\alpha$$

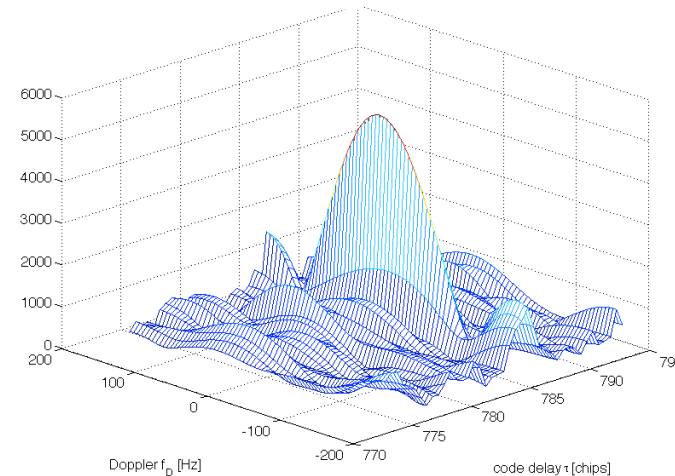
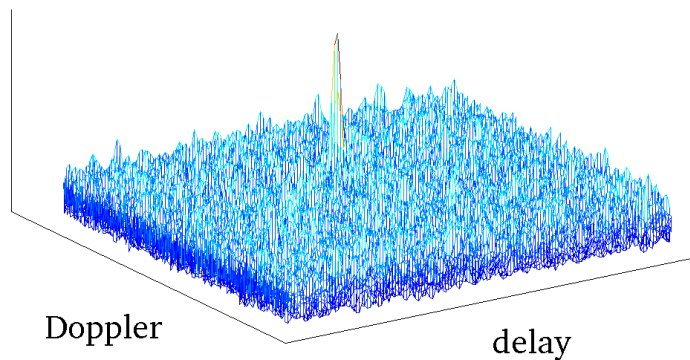

Ambiguity function magnitude complete [3] (left) and zoomed in [11] (right)

- Delay and Doppler values are tried over a search space. Correlation magnitudes are compared to the noise floor—if the carrier to noise spectral density exceeds a threshold, the signal is determined visible and the delay and Doppler at the correlation peak are used to seed tracking.
- Pre-detection integration time, T_I , is an important parameter in detecting weak signals.

GNSS receivers: tracking

- Tracking seeks to refine the delay and Doppler estimates produced by acquisition
 - Input signal is correlated with a local replica
 - Correlation result is filtered to produce error terms that quantify the difference between the input and local signal
 - A feedback process makes adjustments to the local signal replica according to the error terms
- In addition to converging on the input signal delay and Doppler parameters, the tracking of a dynamic signal allows for measurements of changing signal features and more accurate estimates of the signal to noise ratio
- Most receivers compute three correlations per signal: Early, Prompt, and Late
 - Phase of prompt corr. gives error signal for carrier tracking
 - Comparing size of Early and Late corr. gives error signal for PRN code tracking
- Coupled feedback loops DLL and PLL maintain lock on code and carrier signal parameters

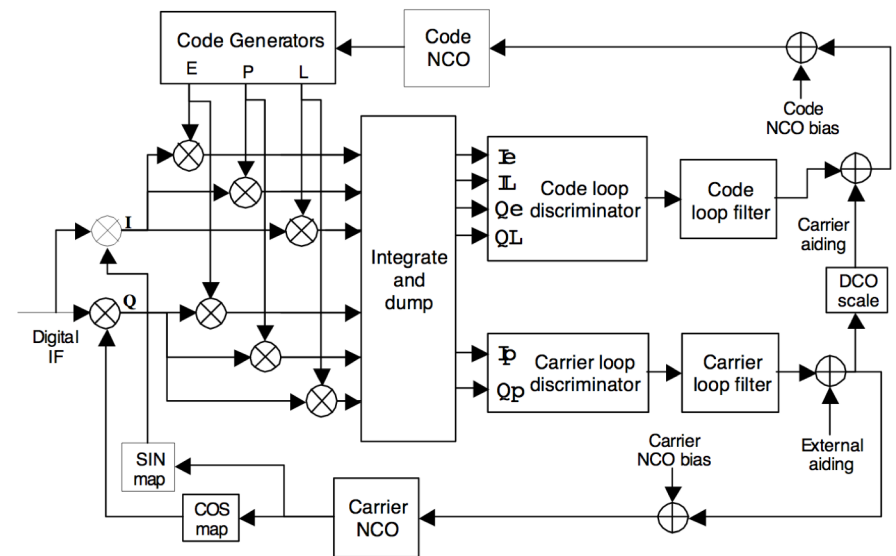

Code and carrier tracking [3] from [11]

GNSS measurements

- GNSS observables (i.e., receiver outputs)
 1. **Pseudorange:** propagation delay plus receiver clock bias (measured from the PRN code to a fraction of a chip: ~meter level accuracy)
 2. **Doppler:** measured frequency shift of the received carrier
 3. **Carrier phase:** measured fractional and accumulated whole cycle phase of the carrier (measured to small fraction of 19 cm cycle: ~mm precision)
 4. **C/N₀:** carrier to noise spectral density estimate in dB-Hz

GNSS measurements: pseudorange

- Pseudorange measured from the i -th satellite (“pseudo” because of receiver clock bias):

$$\rho^i = c(\tilde{t}_r - \tilde{t}_t^i)$$

time of reception according to receiver clock

time of transmission according to satellite clock

GNSS measurements: pseudorange

- Pseudorange measured from the i -th satellite (“pseudo” because of receiver clock bias):

$$\begin{aligned}\rho^i &= c(\tilde{t}_r - \tilde{t}_t^i) \\ &= c((t_r + \delta t_r) - (t_t^i + \delta t_t^i)) + \epsilon\end{aligned}$$

time of reception according to receiver clock

time of transmission according to satellite clock

- Transmission and receive times each expressed as a sum of the “true” time (i.e., the time according to a common time standard, such as GPST) plus an unknown bias

GNSS measurements: pseudorange

- Pseudorange measured from the i -th satellite (“pseudo” because of receiver clock bias):

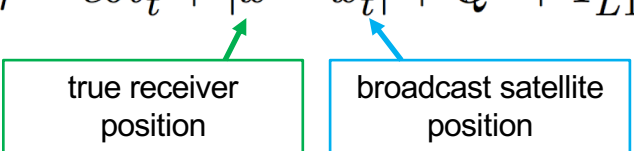
$$\begin{aligned}\rho^i &= c(\tilde{t}_r - \tilde{t}_t^i) \\ &= c((t_r + \delta t_r) - (t_t^i + \delta t_t^i)) + \epsilon \\ &= c\delta t_r - c\delta t_t^i + |x - x_t^i| + Q^i + I_{L1}^i + T^i + \epsilon\end{aligned}$$

- Propagation delay:

$$\tau^i = (r^i + Q^i + I_{L1}^i + T^i)/c$$

r^i is the geometric range between the i -th transmitting satellite and the receiver, $|x - x_t^i|$

Q^i is the satellite orbit error

I_{L1}^i is the delay due to the ionosphere, a region of ionized gas in the upper atmosphere where the time varying density of free electrons and ions introduces a dispersive (frequency dependent) delay

T^i is the delay due to the troposphere, the lowest region of the atmosphere, a non-dispersive medium consisting of dry gases and water vapor

GNSS measurements: pseudorange (cont.)

- Propagation delay:

$$\tau^i = (r^i + Q^i + I_{L1}^i + T^i)/c$$

Acquisition and tracking measure code phase, i.e., ambiguous time of transmission modulo one code period

(1 ms for GPS C/A code, or approximately 300 km): $p(t - \tau)$

The navigation message must be decoded to form a pseudorange

- Navigation message is organized into six second subframes, each beginning with an 8-bit Telemetry word (TLM) and Hand-over word (HOW), the latter of which contains the satellite time the subframe was transmitted

$svtime_of_transmission =$

$svtime_of_subframe$

$+bits_since_subframe_start*0.02$

$+whole_cacodes_since_bit_start*0.001$

$+whole_chips_into_current_cacode/1.023e6$

$+frac_code_phase_chips/1.023e6;$

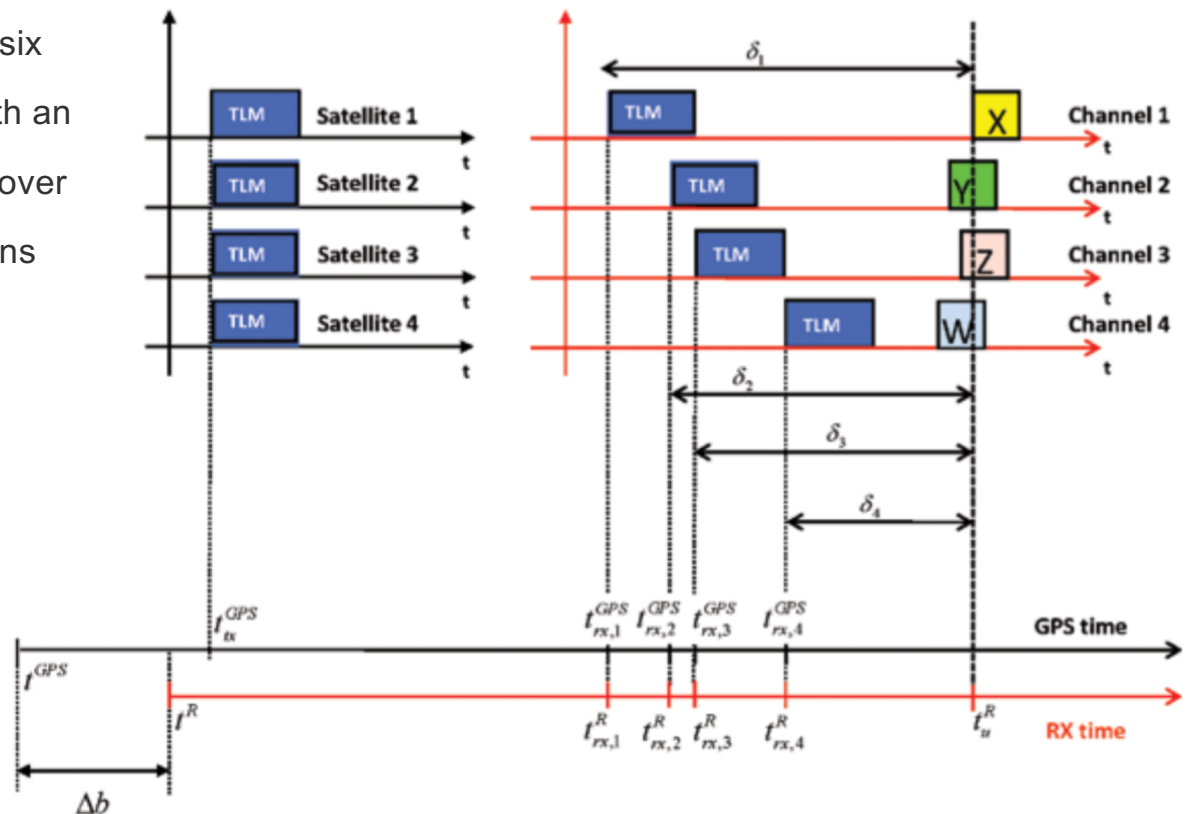

Calculation of pseudorange using four satellites [12]

Training on GNSS 2019 | Pathum Thani, Thailand

Navigation solution: typical GPS error budget

Error Source	Basic single frequency	Precise dual-freq, assisted
Ionosphere (< 1000 km)	~3 m (single frequency, using broadcast model)	Dual frequency <1 cm
Troposphere (< 20 km)	0.1-1 m	1 cm level using estimators, advanced models
GPS orbits	<2.0 m (broadcast ephem)	1 cm, Int. GNSS service (IGS)
GPS clocks	<2.0 m (broadcast clock)	1 cm (IGS)
Multipath ("clean" environment)	0.5-1 m code	0.5-1 cm carrier
Receiver Noise	0.25-0.5 m code	1-2 mm carrier
RSS range error	4 m	2 cm
Typical GDOP	2	2
RSS solution error	8 m	4 cm

- Disclaimer: for illustration purposes only

GNSS measurements: pseudorange (cont.)

- Propagation delay:

$$\tau^i = (r^i + Q^i + I_{L1}^i + T^i)/c$$

- **Orbit error**

Maintained to within ~1 m RSS by Control Segment

- **Ionosphere**

Group delay for pseudorange due to the ionosphere:

$$I_{L1}^i = \frac{40.3}{f_{L1}^2} \text{TEC}$$

where TEC is the Total Electron Content in a 1 m² column from the receiver the transmitter.

Ionospheric delay can be corrected by using measurements from two frequencies (note frequency dependence, here we use GPS L1) or through a model that predicts TEC

GPS uses the Klobuchar model, in which four parameters (defined by eight numbers in the navigation message) are used to define the daily zenith variation at the ionospheric pierce point

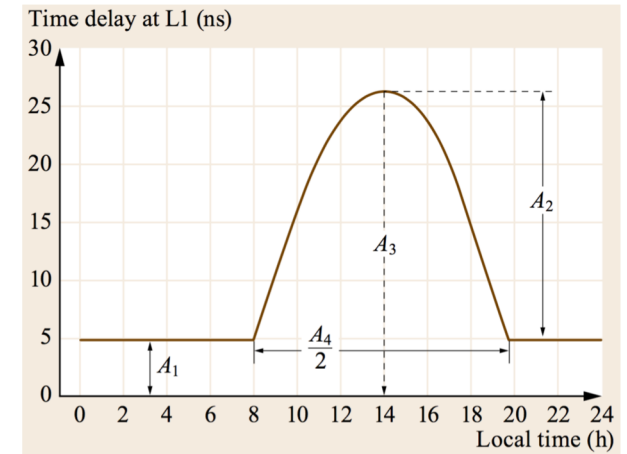

GPS ionospheric delay model: Klobuchar [13]

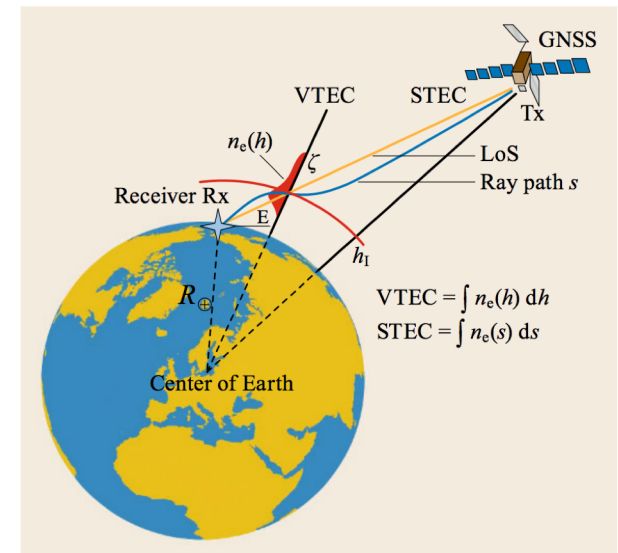

Geometry of zenith TEC (vertical TEC, VTEC) and slant TEC (STEC) [13]

GNSS measurements: pseudorange (cont.)

- Propagation delay:

$$\tau^i = (r^i + Q^i + I_{L1}^i + T^i)/c$$

- **Troposphere**

Not frequency dependent, wet (< 0.25 m, large variation) and dry (~2 m, small variation) components

Corrected using models (e.g., Hopfield) that incorporate empirical corrections—typically average meteorological parameters for latitude, longitude, and season

- Complete pseudorange expression:

$$\rho^i = r^i + ct_{b,r} - ct_{b,s}^i + Q^i + I_{L1}^i + T^i + \epsilon^i$$

- **Relativity**

Second-order Doppler shift: a clock moving in an inertial frame runs slower than a clock at rest

Gravitational frequency shift: a clock at rest in a lower gravitational potential runs slower than a clock at rest in a higher gravitational potential

GNSS space segment atomic clocks are offset to compensate for these effects—without correction satellite clocks would gain almost 40 microseconds per day (~10 km range error)

GNSS measurements: pseudorange (cont.)

- Propagation delay:

$$\rho^i = r^i + ct_{b,r} - ct_{b,s}^i + Q^i + I_{L1}^i + T^i + \epsilon^i$$

- **Multipath**

Reflected signals are received as delayed, attenuated replicas of the direct signal

Correlation shape of the combined signal causes an error in the code tracking loop that depends on geometry, number and strength of reflections, and tracking loop design

E.g., one signal, noncoherent DLL:

$$\tau_M = \frac{\alpha^2 \delta + \alpha \delta \cos \psi}{1 + \alpha^2 + 2\alpha \cos \psi}$$

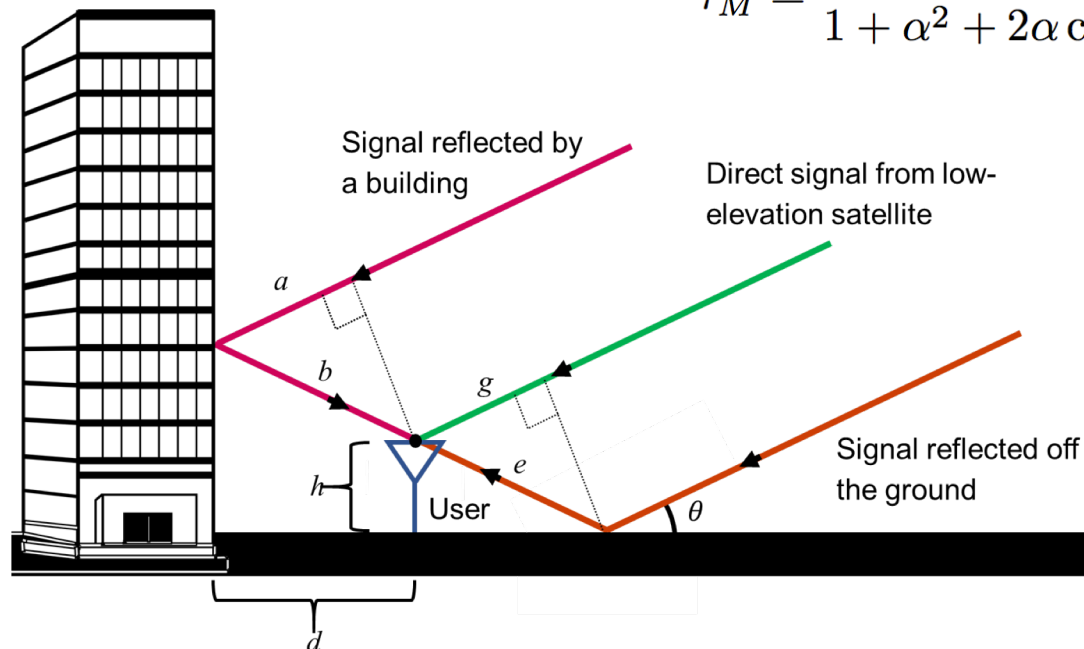

Direct, building-reflected, and ground-reflected signal paths in multipath interference scenario [19]

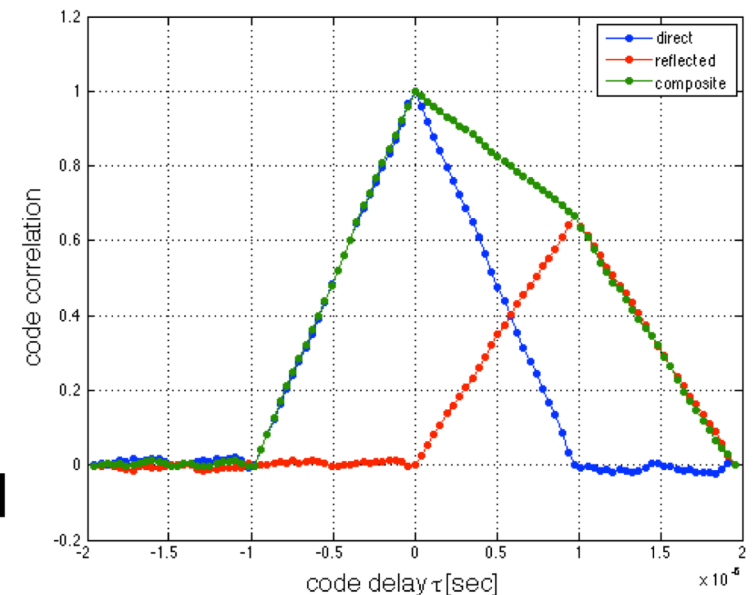

Direct, reflected, and composite correlations [10]

GNSS measurements (cont.)

- Measured **Doppler** shift is a combination of the changing geometric line of sight and the unknown receiver clock drift. Time derivative of the pseudorange:

$$\dot{\rho}^i(t) = \dot{r}^i(t) + ct_{b,r}^i - ct_{b,s}^i$$

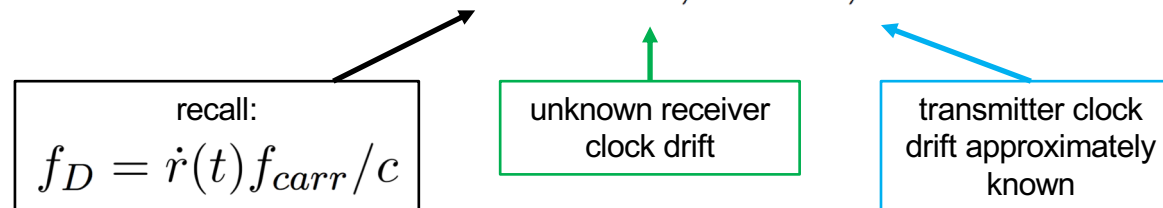

- Carrier phase**

$$\phi^i(t) = -2\pi f_{carr} \rho^i(t) / c + 2\pi M$$

Can be measured with much higher precision than code phase (i.e., pseudorange), ~cm for GPS, but ambiguous on the order of carrier cycles, 19 cm for GPS. Combine with code measurements or use for precise measurement of change (Accumulated Delta Range)

Ionosphere also induces a delay, but opposite in sign relative to pseudorange, leading to a code/carrier divergence

Multipath also introduces an error in carrier phase measurements, as the geometry changes and the received reflections cycle through constructive and destructive interference with the direct signal. For a single reflection:

$$\phi_M^i(t) = (2\pi \Delta^i / \lambda_{carr} + \phi_R^i) \text{MOD} 2\pi$$

GNSS measurements (cont.)

- Carrier phase (cont.)

$$\phi_M^i(t) = (2\pi\Delta^i/\lambda_{carr} + \phi_R^i) \text{MOD}2\pi$$

Wall reflection

$$\Delta = a + b = 2d \cos \theta$$

$$\frac{\partial \phi_M^i}{\partial t} = - \left(\frac{4\pi d}{\lambda_{carr}} \sin \theta \right) \frac{\partial \theta}{\partial t}$$

Ground reflection

$$\Delta = e - g = 2h \sin \theta$$

$$\frac{\partial \phi_M^i}{\partial t} = \left(\frac{4\pi h}{\lambda_{carr}} \cos \theta \right) \frac{\partial \theta}{\partial t}$$

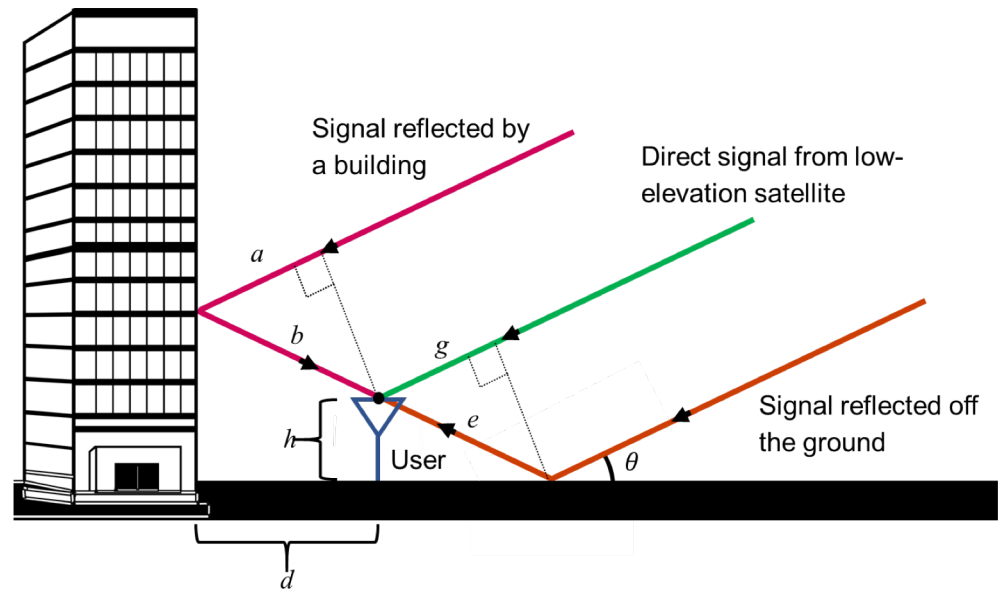

Direct, building-reflected, and ground-reflected signal paths in multipath interference scenario [19]

- Carrier to noise spectral density (C/N₀)** is the signal power divided by the measurement noise power density. Unlike signal to noise ratio, SNR, this is independent of the receiver bandwidth *B*. It is a power to noise density per unit frequency, expressed in units dB-Hz:

$$\frac{C}{N_0} = SNR + B = (P_R - B - N_0) + B$$

GNSS measurements: link budget

- GNSS link budget

The received signal power is a combination of power spatial density produced by the transmitter at the receiver and the effective area of the receive antenna:

$$P_R = \mathcal{P}_{T,rcvr} A_R$$

Effective area is a measure of an antenna's ability to capture power in an electric field on the antenna from a certain direction, defined as: $A_{eff} = G\lambda^2/4\pi$

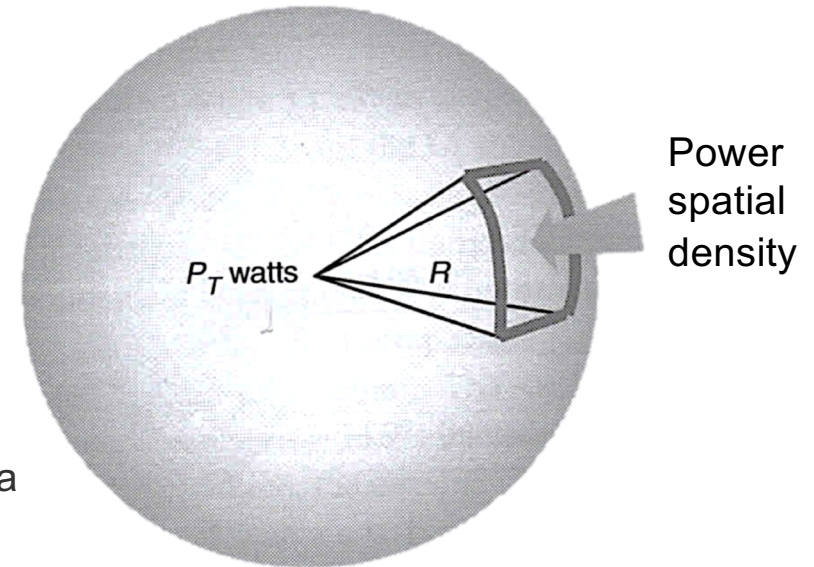

Power spatial density [1]

An isotropic antenna radiates power equally in all directions. At a given distance from the transmitter, R , the power density is simply the transmitted power divided by the surface area of the sphere: $P_T/(4\pi R^2)$ This accounts for spreading loss.

Spreading loss can be offset by focusing the transmitted power in a particular direction, a property described by the transmit antenna gain, G_T . The power density at the receiver is:

$$\mathcal{P}_{T,rcvr} = \frac{P_T G_T}{4\pi R^2}$$

GNSS measurements: link budget

- GNSS received power

The power density at the receiver is:

$$\mathcal{P}_{T,rcvr} = \frac{P_T G_T}{4\pi R^2}$$

Thus for receive antenna gain G_R the received power is given by the Friis transmission formula:

$$P_R = \frac{P_T G_T G_R \lambda^2}{(4\pi)^2}$$

- Noise power per frequency unit: $N_0 = kT_{Eff}$

Effective temperature used to characterize all noise, not just thermal

- Carrier to Noise Spectral Density

$$\frac{C}{N_0} = \frac{P_R}{N_0} = \frac{P_R}{P_N} \frac{1}{B}$$

Typical values for GPS:

$$T_E = 290 \text{ K} \rightarrow N_0 = -201 \text{ dBW-Hz}, P_R = -156 \text{ dBW} \rightarrow C/N_0 = 45 \text{ dB-Hz}$$

Summary of GNSS receiver procedure

1. Point antenna toward sky signals
2. Receiver acquires and tracks 4 or more signals
3. At any given moment, latch code/carrier phase observables for 4+ signals
4. Form pseudoranges from code/carrier observables, correct with error models
5. Solve overdetermined system of nonlinear equations in least squares sense
6. Output position, velocity, and time (PVT) to user

Outline

- I. GNSS signals
- II. GNSS receivers
- III. Measurements
- IV. Time reference, orbits, coordinate frames
- V. Navigation solution

$$y^i(t) = \sqrt{2P_R} d^i(t - \tau^i(t)) p^i(t - \tau^i(t)) \cos(2\pi(f_{L1} + f_D^i)t + \theta^i(t_0)) + v^i(t)$$

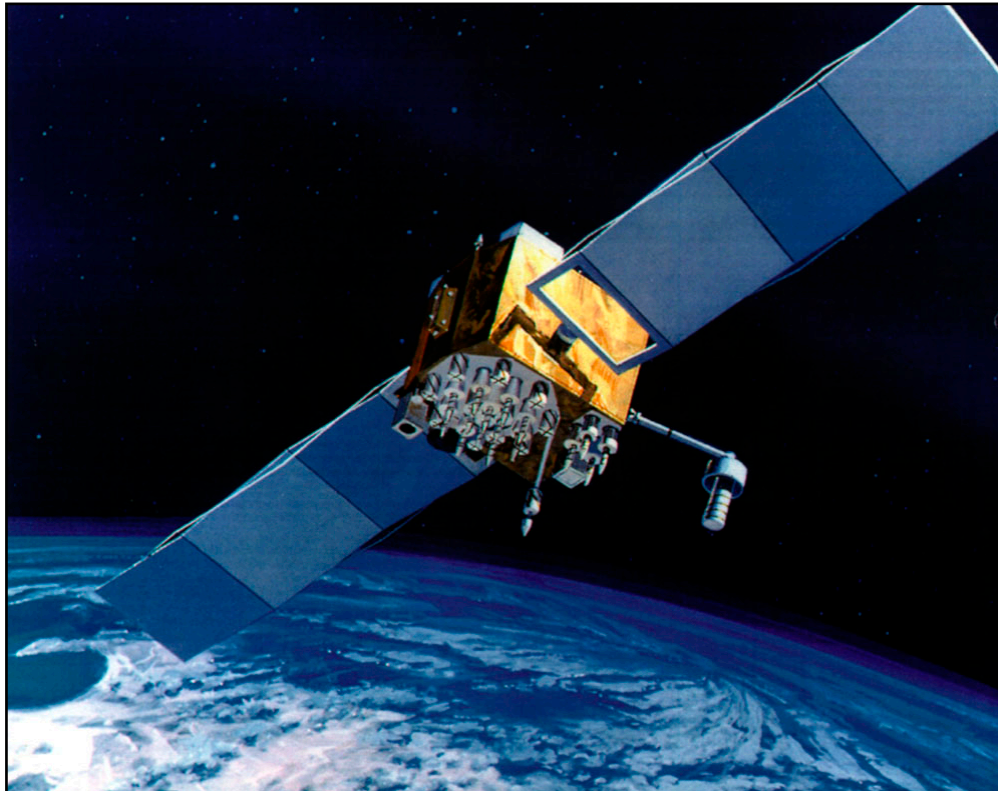

GNSS time reference

- GNSS requires a common time scale for computing ranges
- GPS Time (GPST) is the operational time scale of GPS
- To keep satellites on GPST adequately, atomic clocks are required
 - Corrections in the navigation message are used to synchronize satellites to GPST
 - For example, to limit clock error to 1 m over 12 hrs requires drift $< 8 \times 10^{-14}$ s/s
- GPST coarsely steered to align with Universal Consolidated Time (UTC) as maintained by the US Naval Observatory via corrections in the navigation message
- **Traceability to UTC USNO enables precise time and frequency transfer on a global scale**

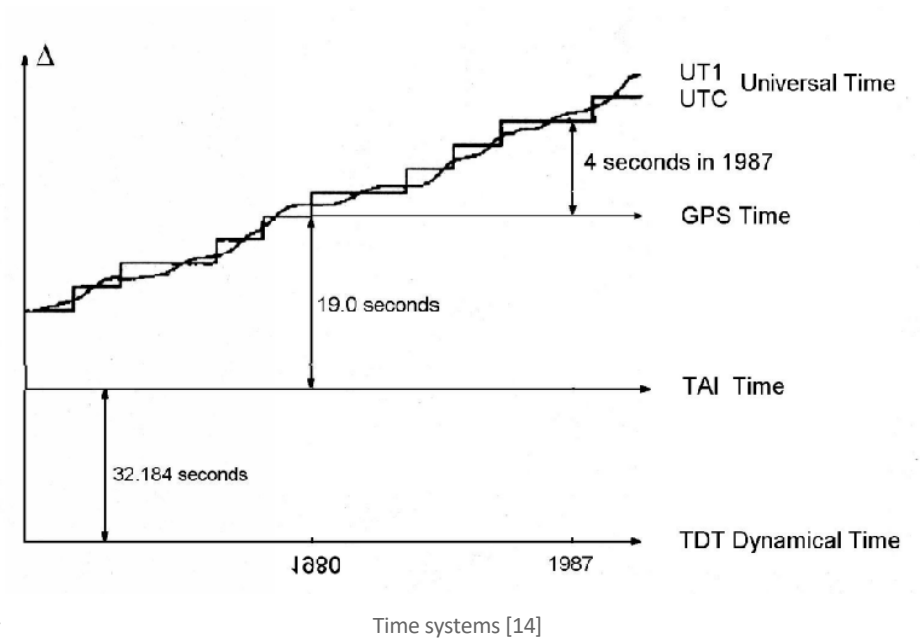

- Tidal friction and other processes that cause a significant redistribution of mass are slowing the Earth's rotation, lengthening the solar day by ~ 2 ms / century
- UTC incorporates leap seconds to maintain alignment with sidereal time (UT1), but GPST does not. This difference is a persistent challenge for receiver designers and users.

GNSS orbits

- Satellites make great reference points
 - Small number can provide global coverage
 - They can be precisely located
- Orbital mechanics are well understood and satellite orbit determination is a refined science; for GPS, for example, the MCS estimates and predicts satellite orbits to less than 1 m
- Dual frequency observables from a network of monitor stations used to estimate orbits and satellite clock biases
- Each GPS satellite broadcasts its ephemeris (valid for 2-4 hours) and an almanac (subset of ephemeris parameters for every satellite in the constellation—not accurate enough for navigation, but accurate enough for a satellite search)
- International GNSS Service (IGS) and others maintain large networks of monitor stations, use advanced techniques to locate satellites with cm-level accuracy

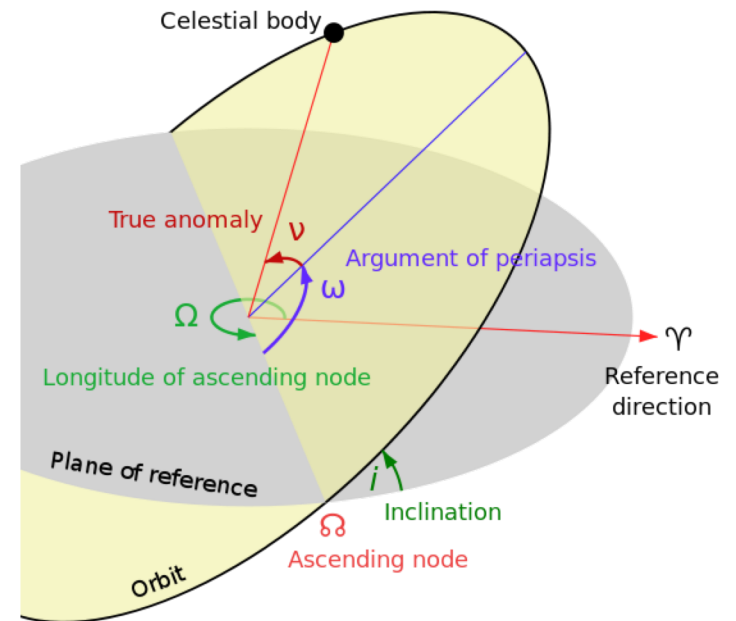

Keplerian elements [16]

GNSS Coordinate Frames

- Earth Centered Earth Fixed (rotating reference frame) versus Earth Centered Inertial (ECI)

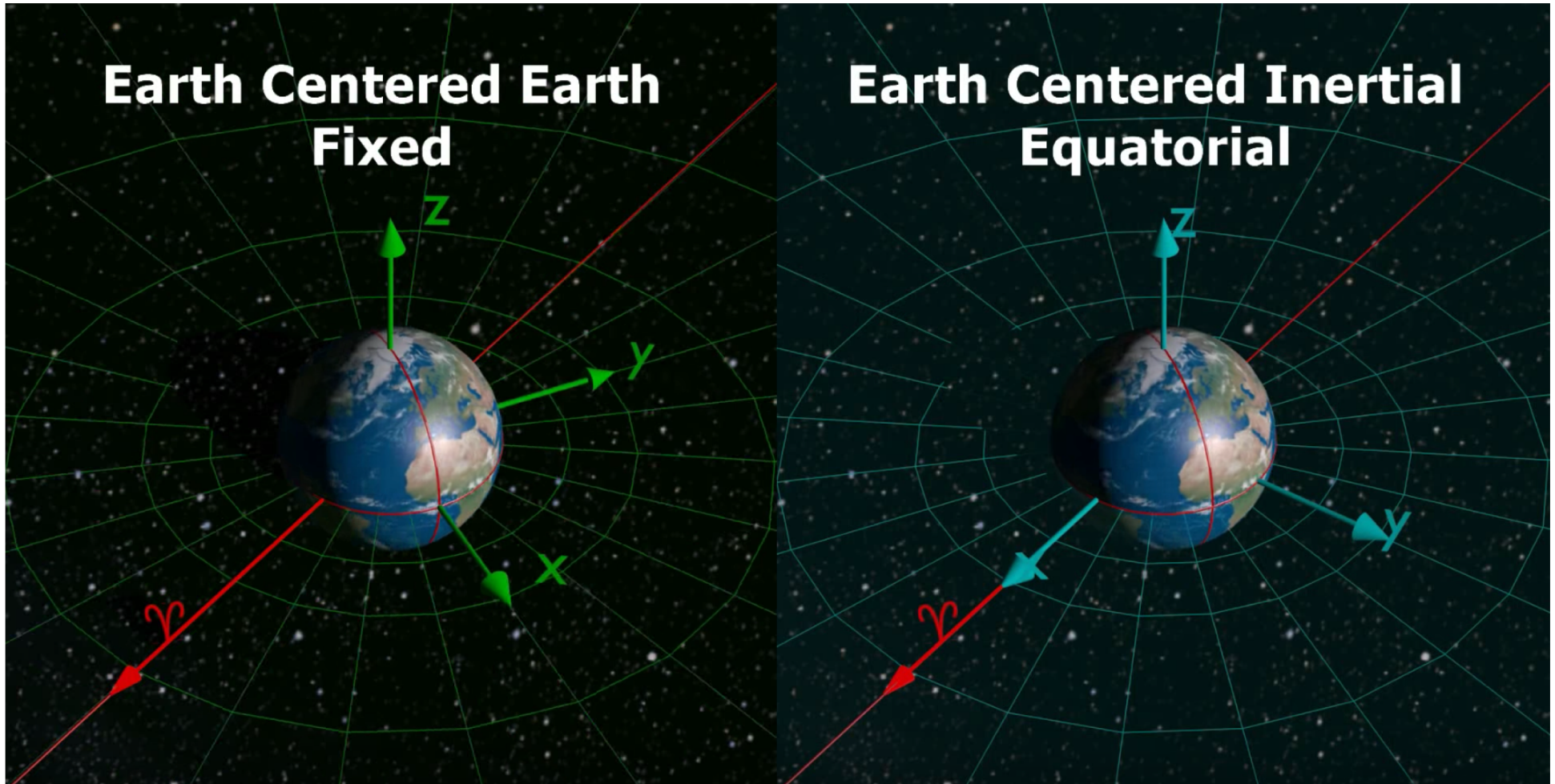

ECEF and ECI reference frames animation [15]

- Explanatory video: <https://youtu.be/DbYapFLJsPA>

GNSS Coordinate Frames

- GNSS orbit determination is performed in an inertial (non-rotating) frame
Example: Earth Mean Equator and Mean Equinox of the J2000 epoch (January 1, 2000 at 12:00 TT), x-axis is aligned with the mean equinox, z-axis aligned with the Earth's spin axis or celestial north Pole
- Terrestrial navigation is performed in an Earth-fixed frame (rotating with the Earth) for convenience to users
Example: GPS uses the WGS84 frame, a 3-dimensional coordinate reference frame for establishing geodetic latitude, longitude, and heights for navigation. Defined by the US National Geospatial Intelligence Agency.



Navigation solution

- Position estimation with pseudorange

Want to estimate receiver position and clock bias at some instant in time:

$$\mathbf{x} = \begin{bmatrix} x & y & z \end{bmatrix} \text{ and } b = c\delta t_{b,r}$$

Given $N > 4$ pseudorange measurements (corrected for transmitter clock bias):

$$\rho^i = |\mathbf{x} - \mathbf{x}_t^i| + b + v^i$$

Standard approach is to solve as a non-linear least squares (NLLS) problem by Gauss-Newton method:

$$\text{minimize } J(\hat{\mathbf{x}}, \hat{b}) = \sum_{i=1}^N \left(\rho^i - (|\hat{\mathbf{x}} - \mathbf{x}_t^i| + \hat{b}) \right)^2$$

1. Linearize about initial guess $(\hat{\mathbf{x}}_0, \hat{b}_0)$
2. Solve linear least squares problem for $(d\hat{\mathbf{x}}, d\hat{b})$
3. Set $\hat{\mathbf{x}}_1 = \hat{\mathbf{x}}_0 + d\hat{\mathbf{x}}, \hat{b}_1 = \hat{b}_0 + d\hat{b}$
4. Iterate

Navigation solution: DOP

- In general, when solving the linear least squares problem

$$z = H\theta + v, \text{Cov}\{z\} = \sigma_z^2 I$$

- The covariance of the least squares solution θ^* is

$$\sigma_\theta^2 = \text{Cov}\{\theta^*\} = \sigma_z^2 (H^T H)^{-1} = \sigma_z^2 W$$

- W (the inverse Gramian matrix) transforms measurement noise into solution noise

- In GPS, the i -th row of H is

$$\mathbf{h}_i = [\mathbf{u}_i^T, 1] \text{ with } \mathbf{u}_i = \frac{\mathbf{x} - \mathbf{x}_t^i}{|\mathbf{x} - \mathbf{x}_t^i|} \text{ (unit vector from transmitter to receiver)}$$

- Thus, W is determined by the geometry of the visible transmitters. Dilution of Precision (DOP):

$$GDOP := \sqrt{\sum_{i=1}^4 W_{ii}} \quad PDOP := \sqrt{\sum_{i=1}^3 W_{ii}} \quad TDOP := \sqrt{W_{44}}$$

- Examples

If transmitters are in a plane, H is rank deficient and $GDOP = \infty$

If transmitters are located at corners of a tetrahedron $GDOP = \sqrt{3}$ (minimum for $N = 4$)

Improving performance

- Multi-frequency receivers
 - Eliminate ionosphere as an error source through “ionosphere-free combination”
- Carrier phase observables
 - Millimeter rather than meter level measurement noise and negligible multipath error
- Differential measurements: Receivers in close proximity can be used to cancel common error sources (e.g., Differential GPS, DGPS)
 - Ionosphere, troposphere, satellite orbit/clock can be cancelled by differencing measurements or solutions
 - Solution is relative
- Precision GNSS orbits and clocks
 - Available from global networks of reference receivers (e.g., International GNSS Service, ICG) for post-processing and in near real-time
- Augmentations
 - Additional transmitters and measurements enhance geometry
- Filtering
 - Incorporate dynamic constraints or additional measurement sources (e.g., inertial sensors)
- **A combination of these techniques enables cm to mm level solutions**

References

- Luke Winternitz, “Introduction to GPS and other Global Navigation Satellite Systems,” in *Proceedings of the 43rd Annual Time and Frequency Metrology Seminar*, Boulder, CO, 14 June 2018.
- James Garrison, *AAE575: Introduction to Satellite Navigation and Positioning*, Purdue University, Fall 2011.
- Pratap Misra and Per Enge, *Global Positioning System*, 2nd ed. Lincoln, MA: Ganga-Jamuna Press, 2005.



Introduction to GPS and other Global Navigation Satellite Systems

Luke Winternitz
NASA/Goddard Space Flight Center Code 596
(Acknowledgment to Mike Moreau NASA/GSFC Code 595)

43rd Annual Time and Frequency Metrology Seminar
14 June 2018

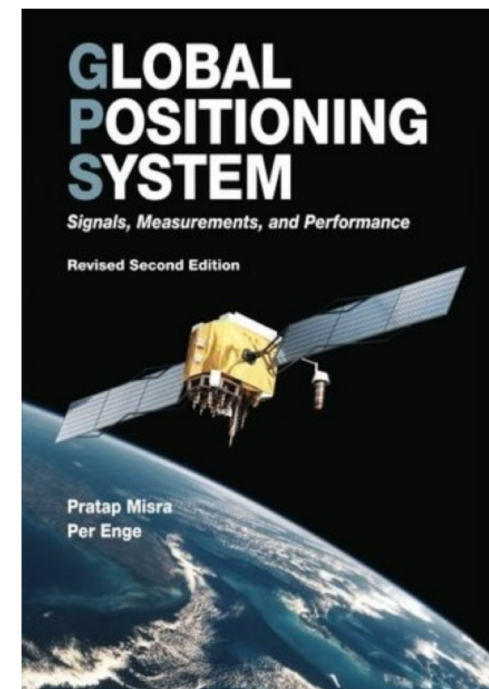
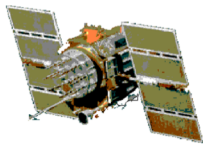



Benjamin Ashman, Ph.D.

Navigation and Mission Design Branch

Code 595, NASA Goddard Space Flight Center

Greenbelt, MD 20771

benjamin.w.ashman@nasa.gov

Image references

1. M. Pratap and P. Enge, Global Positioning System, 2nd ed. Lincoln, MA: Ganga-Jamuna Press, 2005.
2. https://mk0spaceflightnoa02a.kinstacdn.com/wp-content/uploads/2014/12/GPS_IIF.jpg
3. Luke Winternitz, "Introduction to GPS and other Global Navigation Satellite Systems," in Proceedings of the 43rd Annual Time and Frequency Metrology Seminar, Boulder, CO, 14 June 2018.
4. <https://www.gps.gov/multimedia/images/constellation.jpg>
5. <https://www.gps.gov/multimedia/images/GPS-control-segment-map.pdf>
6. <http://www8.garmin.com/aboutGPS/>
7. <http://www.elenageosystems.com/GNSS.aspx>
8. <https://natronics.github.io/blag/2014/gps-viz-1/>
9. <https://smd-prod.s3.amazonaws.com/science-blue/s3fs-public/thumbnails/image/EMS-Introduction.jpeg>
10. B. Ashman, "Incorporation of GNSS Multipath to Improve Autonomous Rendezvous, Docking, and Proximity Operations," Ph.D. dissertation, Purdue University, 2016.
11. M. Moreau, "GPS Receiver Architecture for Autonomous Navigation in High Earth Orbits," Ph.D. dissertation, University of Colorado, 2001.
12. http://insidegnss.com/wp-content/uploads/2018/01/IGM_janfeb12-Solutions.pdf
13. https://link.springer.com/chapter/10.1007/978-3-319-42928-1_6
14. http://www.navipedia.net/index.php/Transformations_between_Time_Systems
15. <https://youtu.be/DbYapFLJsPA>
16. https://en.wikipedia.org/wiki/Orbital_elements#/media/File:Orbit1.svg
17. B. Ashman, J. Parker, F. Bauer, M. Esswein, "Exploring the Limits of High Altitude GPS for Lunar Missions," AAS GN&C Conference, Breckenridge, CO, American Astronautical Society, February 2018.
18. J. Miller and J. Parker, "NASA GNSS Activities," International Committee on GNSS 12, Kyoto, Japan, December 2017.
19. G. McGraw, P. Groves, and B. Ashman, "Robust Positioning in the Presence of Multipath and NLOS GNSS Signals," Chapter 21 in 21st Century PNT, Jade Morton editor, 2018.
20. National Geographic March 2018

Image references (cont.)

21. <https://timeandnavigation.si.edu/navigating-at-sea/navigating-without-a-clock/celestial-navigation>
22. Winkler, S., Ramsey, G., Frey, C., Chapel, J., Chu, D., Freesland, D., Krimchansky, A., and Concha, M., "GPS Receiver On-Orbit Performance for the GOES-R Spacecraft," ESA GNC 2017, 29 May-2 Jun 2017, Salzburg, Austria.
23. By Persimplex - Own work, CC BY-SA 3.0, <https://commons.wikimedia.org/w/index.php?curid=18957671>

Optimality of correlation with respect to SNR

An optimal decision statistic is one that maximizes the signal to noise ratio (SNR). This means that for an input signal $x(t) = s(t) + n(t)$, with signal component $s(t)$ and AWGN $n(t)$, a linear time invariant (LTI) process, $h(t)$, is needed that maximizes the SNR of the output $z(t) = z_s(t) + z_n(t)$. In terms of the input and $h(t)$, the output is

$$z(t) = \int_{-\infty}^{\infty} h(\tau)x(t - \tau) d\tau + \int_{-\infty}^{\infty} h(\tau)n(t - \tau) d\tau,$$

and the SNR of the output sampled at time T_I is

$$SNR \equiv \frac{|z_s(T_I)|^2}{E[|z_n(T_I)|^2]},$$

so the problem is to find

$$h_M(t) = \arg \max_{h(t)} \frac{|z_s(T_I)|^2}{E[|z_n(T_I)|^2]}.$$

By Parseval's theorem,

$$|z_s(T_I)|^2 = \left| \int_{-\infty}^{\infty} h(\tau)s(T_I - \tau) d\tau \right|^2 = \left| \int_{-\infty}^{\infty} H(f)S(f)e^{i2\pi T_I f} df \right|^2$$

and

$$E[|z_n(T_I)|^2] = R_{z_n, z_n}(0) = \int_{-\infty}^{\infty} S_{z_n, z_n}(f) df = \int_{-\infty}^{\infty} |H(f)|^2 S_{nn}(f) df.$$

Optimality of correlation (cont.)

For white noise, $S(f) = N_0/2$, so

$$SNR = \frac{\left| \int_{-\infty}^{\infty} H(f) S(f) e^{i2\pi T_I f} df \right|^2}{\frac{N_0}{2} \int_{-\infty}^{\infty} |H(f)|^2 df}.$$

By the Schwartz inequality, for any two square-integrable functions f and g

$$\left| \int f(t)g(t) dt \right|^2 \leq \int |f(t)|^2 dt \cdot \int |g(t)|^2 dt,$$

with equality if and only if $f(t) = \lambda g^*(t)$, where λ is a scalar and the asterisk indicates complex conjugate. Signal to noise ratio is therefore bounded:

$$SNR \leq \frac{\int_{-\infty}^{\infty} |H(f)|^2 df \int_{-\infty}^{\infty} |S(f)|^2 df}{\frac{N_0}{2} \int_{-\infty}^{\infty} |H(f)|^2 df} = \frac{2}{N_0} \int_{-\infty}^{\infty} |S(f)|^2 df.$$

Equality holds when $H(f) = \lambda S^*(f) e^{-2\pi f T_I}$. This corresponds to

$$h(t) = \mathcal{F}^{-1} \{H(f)\} = \lambda s(T_I - t).$$

Thus, SNR is maximized when $h(t)$ is a scaled, flipped, time-delayed copy of the input signal.

- See *Introduction to Digital Communications* by Michael B. Pursley